

ETHICON

PART OF THE *Johnson & Johnson* FAMILY OF COMPANIES

PRODUCT CATALOG

Sutures

Hernia Solutions

Biosurgicals



Our Credo

We believe our first responsibility is to the doctors, nurses and patients,
to mothers and fathers and all others who use our products and services.

In meeting their needs everything we do must be of high quality.

We must constantly strive to reduce our costs
in order to maintain reasonable prices.

Customers' orders must be serviced promptly and accurately.

Our suppliers and distributors must have an opportunity
to make a fair profit.

We are responsible to our employees,
the men and women who work with us throughout the world.

Everyone must be considered as an individual.

We must respect their dignity and recognize their merit.

They must have a sense of security in their jobs.

Compensation must be fair and adequate,
and working conditions clean, orderly and safe.

We must be mindful of ways to help our employees fulfill
their family responsibilities.

Employees must feel free to make suggestions and complaints.

There must be equal opportunity for employment, development
and advancement for those qualified.

We must provide competent management,
and their actions must be just and ethical.

We are responsible to the communities in which we live and work
and to the world community as well.

We must be good citizens — support good works and charities
and bear our fair share of taxes.

We must encourage civic improvements and better health and education.

We must maintain in good order
the property we are privileged to use,
protecting the environment and natural resources.

Our final responsibility is to our stockholders.

Business must make a sound profit.

We must experiment with new ideas.

Research must be carried on, innovative programs developed
and mistakes paid for.

New equipment must be purchased, new facilities provided
and new products launched.

Reserves must be created to provide for adverse times.

When we operate according to these principles,
the stockholders should realize a fair return.

Johnson & Johnson

Our trademarks

ABSOLOK
ATRALOC
BLAKE
CONTROL RELEASE
CS ULTIMA
DERMABOND
EASY ACCESS
ENDOKNOT
ENDOLOOP
ENDOPATH
ENDOPOUCH
ETHALLOY
ETHIBINDER
ETHIBOND
ETHICON
ETHI-ENDO-NAHT
ETHIGUARD
ETHILON
ETHILOOP
ETHIPIN
ETHIZIP

ETHISORB
ETHILOCK
ETHITOUCH
EVERPOINT
EVICEL
HEMO-SEAL
LIGACLIP
LIGAPAK
MERSILENE
MERSILK
MERSUTURES
MICROPOINT
MONOCRYL
MULTIPASS
NUROLON
OMNEX
PDS
PERMA-HAND
POWERSTAR
PRIME
PRINEO
PROLENE

PRONOVA
PROCEED
PROXIMATE
PROXI-STRIP
RELAY
SABRELOC
SECURESTRAP
SLIM BLADE
STRATAFIX
SUTUPAK
SURGICEL
SPONGOSTAN
STRATAFIX
SURGIFLO
TAPERCUT
ULTRAPRO
VICRYL
VISI-BLACK
VYPRO

Selection and use of surgical needles

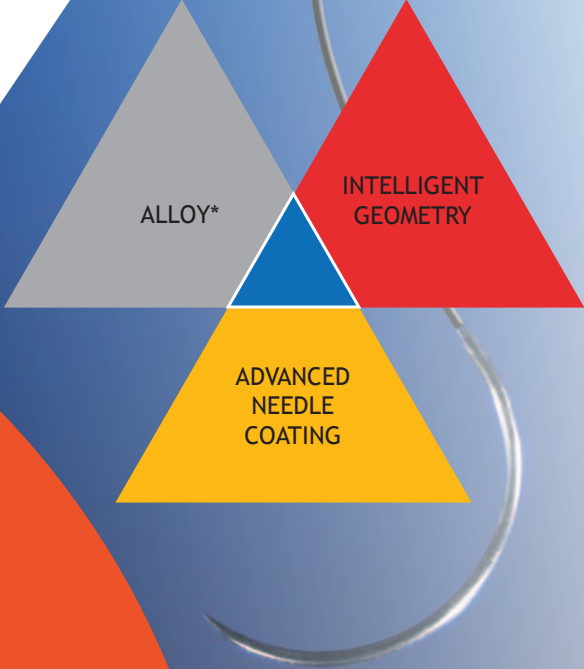

Intelligent Geometry

A Unique Needle Range

ETHIGUARD Blunt Point Needles

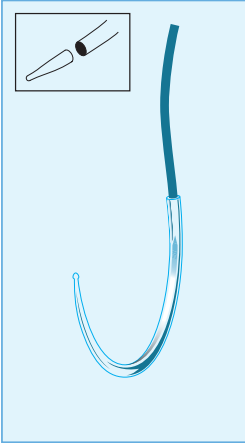

Improving safety

Taper Point Needles

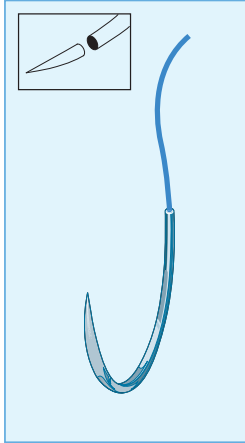

Gentle separation of fibrous tissue

BV Needles

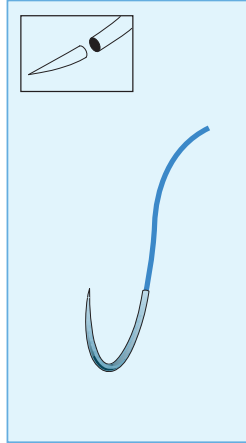

Consistency pass after pass

VISI-BLACK Needles

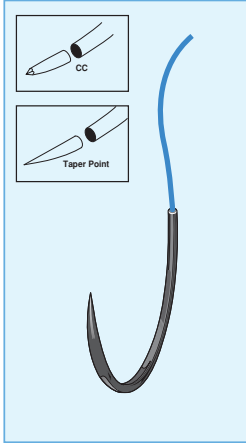

Visibility is their strength

CC Needles

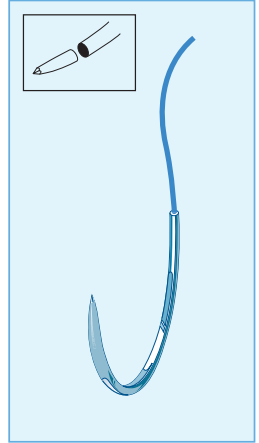

Easy penetration of calcified coronary tissues

HEMO-SEAL Needle Sutures

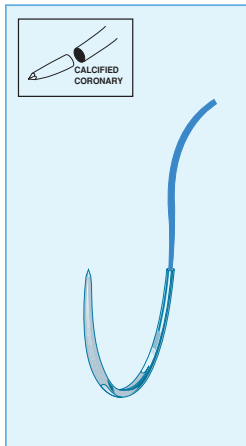

A fitting choice for vascular surgery

MULTICURVE Needles

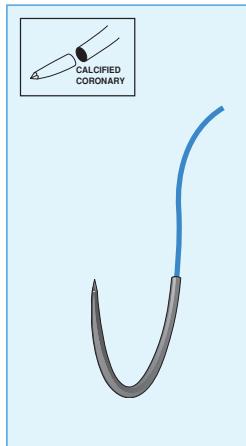

For confined access procedures

TAPERCUT Needles

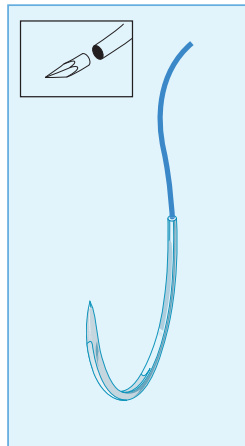

Easy penetration of dense tough tissue

PRIME Needles

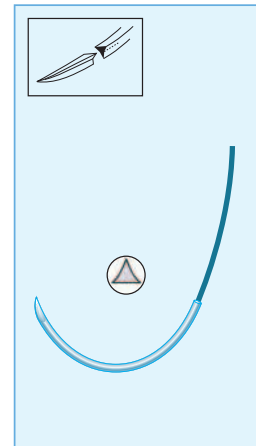

Excellence in skin closure

Anatomy of a Needle

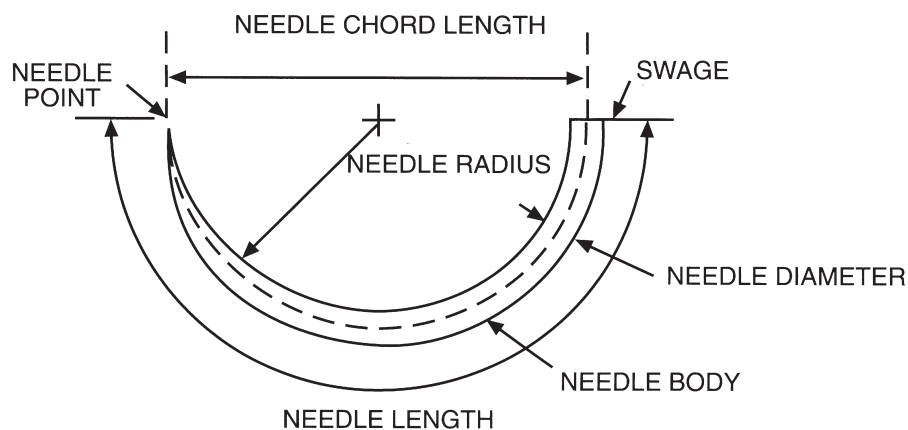



Needle Point Needles can taper to a point or have cutting edges.

Taper Ratio Longer points for improved penetration.

Needle Body

 **Needle flat** Flatted section for stability in the needle holder.

 **Ribs** In larger needles there is a ribbed section to provide a secure grip.

 **Square Body** Needles can also have a square body for increased strength.

Swage A hole is drilled into the end of the wire and the material is attached into this hole. For premium needles the needles are laser drilled which provides a smooth transition between needle and material thus reducing tissue trauma.

Needle Shape

The choice of needle shape is frequently governed by the accessibility of the tissue to be sutured, and normally the more confined the operative site the greater the curvature required. The basic shapes involved are:

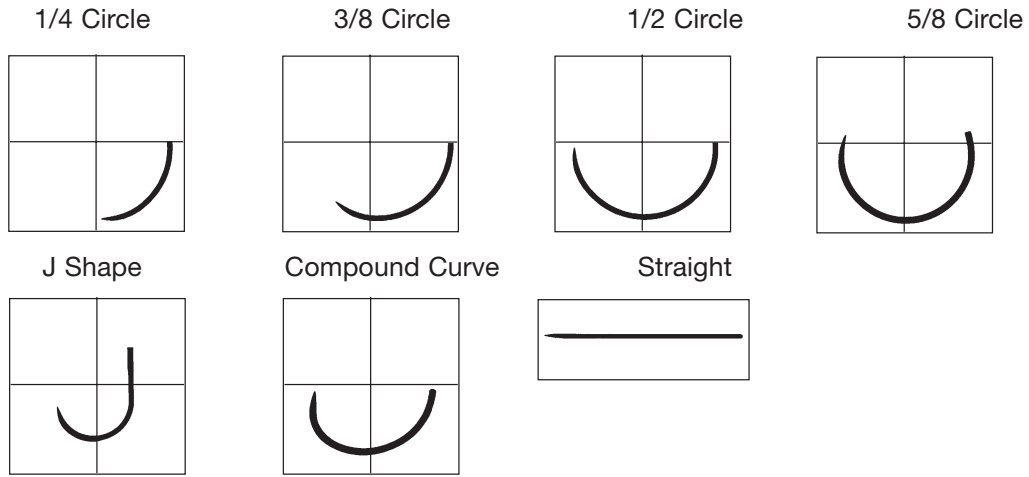

Round Bodied needles

Round Bodied needles are designed to separate tissue fibres rather than cut them. They are used either for soft tissue or in situations where easy splitting of tissue fibres is possible. After the passage of the needle, the tissue closes tightly round the suture material, thereby forming a leak-proof suture line which is particularly vital in Intestinal and Cardio-vascular surgery.

Round Bodied needles are manufactured with different wire diameters according to the tissue to be sutured. For softer tissue such as bowel finer wire diameters can be used. Whereas for muscle or fascia heavier wire diameters are required.

TAPERPOINT Needle

This point profile is engineered to provide easy penetration of intended tissues. Forceps flats are formed in an area half way between the point and the attachment, Positioning the needle holder in this area confers extra stability on the needle being held, aiding precise placement of the sutures. Taper Point needles are available in a range of wire diameters and the finer diameters can be used for softer tissue in gastrointestinal or vascular procedures whereas heavier diameters are required for tougher tissue such as muscle.

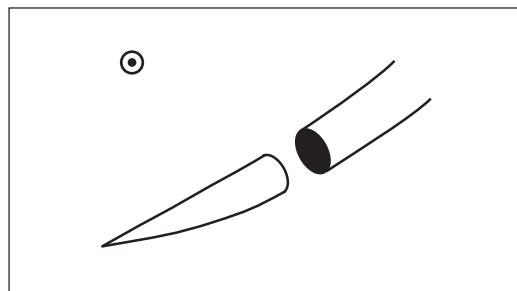

TAPERPOINT Plus

A modified point profile for most of our needles. In a modified profile, the tapered cross section immediately behind the tip has been flattened to an oval shape rather than a conventional round shape. This continues for several millimeters before merging into the conventional round bodied cross section. This design was developed to help facilitate improved separation of tissue layers.

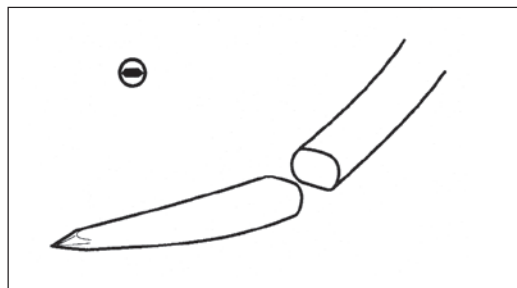

VISI - BLACK Needle

These black needles have been designed to give outstanding visibility against tissue and where blood is present in the operating field. The slim Taper Point design of the VISIBLACK Needle brings improved penetration properties and minimises tissue trauma.

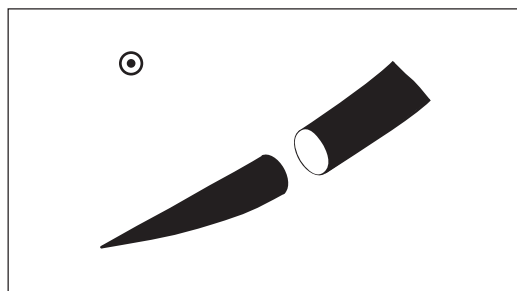

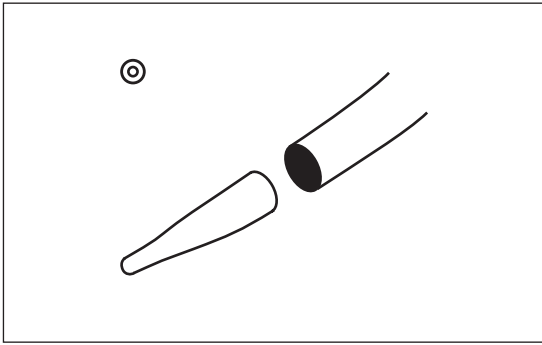

ETHIGUARD Blunt Point Needle

The needles has been designed to minimise the risk of needle stick injury. The ETHIGUARD Needle point is sharp enough to penetrate fascia and muscle but not skin. Virtually eliminating accidental glove puncture, the ETHIGUARD Needle can also be used for suturing friable tissue such as the liver.

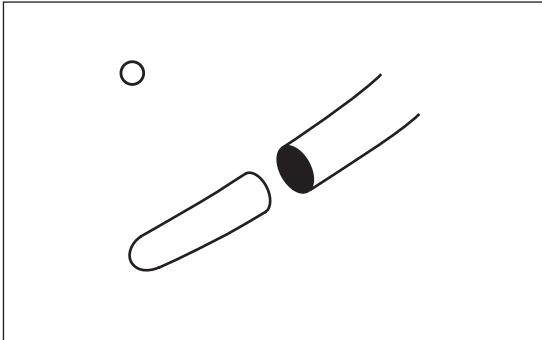

Blunt Point Needle

This needle has been designed for suturing extremely friable tissue such as the liver.

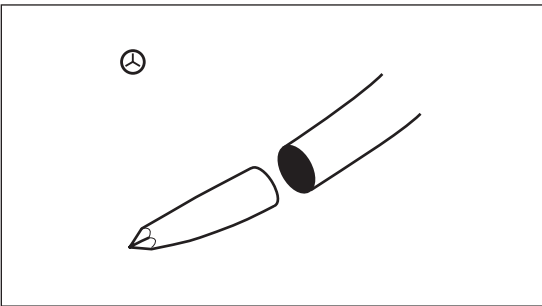

CC Needle

The unique point design of the CC Needle provides significantly improved penetration properties for the Cardiac / Vascular surgeon when suturing tough, calcified vessels. This is achieved with no increase in tissue trauma compared to the conventional round bodied needle. Squared body geometry, in addition to providing a stronger fine vascular needle, also means this needle is particularly secure in the needle holder.

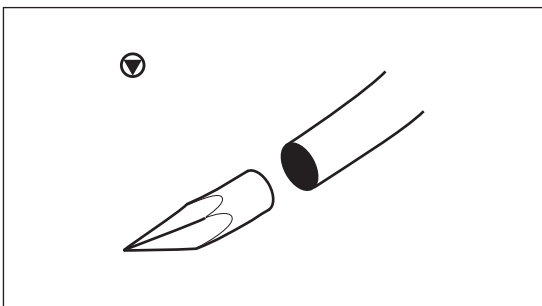

TAPERCUT Needle

This needle combines the initial penetration of a cutting needle with the minimised trauma of a round bodied needle. The cutting tip is limited to the point of the needle, which then tapers out to merge smoothly into a round cross section.

Cutting Needles - for Fibrous Tissue

Cutting needles are required wherever fibrous or dense tissue needs to be sutured.

Reverse Cutting Needle

The body of this needle is triangular in cross section, having the apex cutting edge on the outside of the needle curvature. This improves the strength of the needle and particularly increases its resistance to bending.

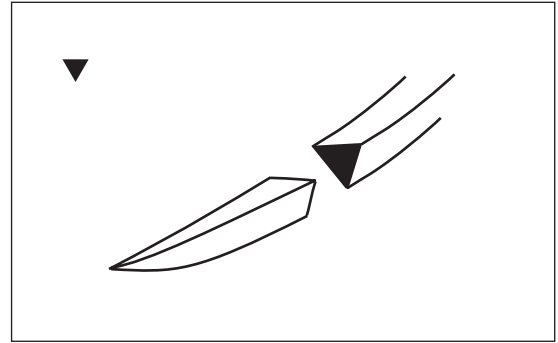

TROCAR POINT Needle

Based on the traditional TROCAR POINT, this needle has a strong cutting head which then merges into a robust round body. The design of the cutting head ensures powerful penetration, even when deep in dense tissue.

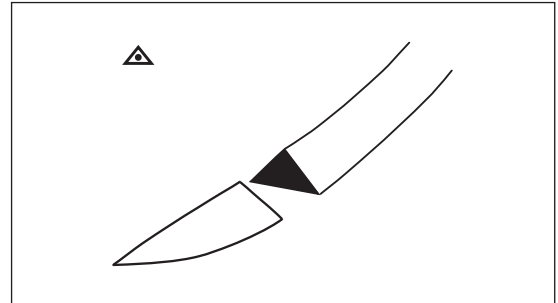

Cutting Needles for Plastic and Cosmetic Surgery

PRIME and PRIME MULTIPASS needles

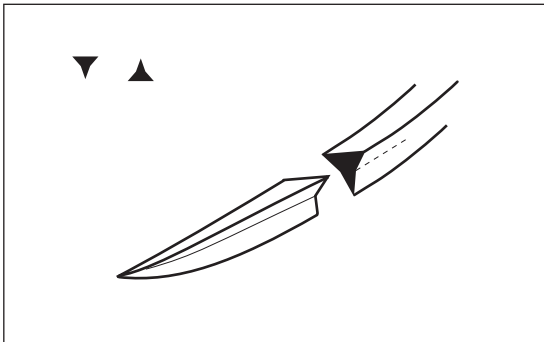

PRIME and PRIME MULTIPASS needles are manufactured with an exclusive needle tip design. The cross sectional geometry of the needle tip reduces the angles of the cutting edges which gives improved penetration and control.

A square body on the needle greatly increases needle strength and offers improved stability in the needle holder. PRIME needles are available with either a reverse cutting or a conventional cutting profile.

PRIME MULTIPASS needles offer PRIME geometry and advanced MULTIPASS needle coating technology.

SUPERIOR EASE OF PENETRATION

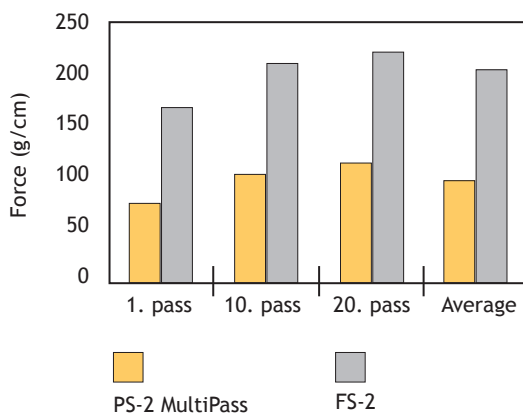

SUPERIOR RESISTANCE TO BENDING

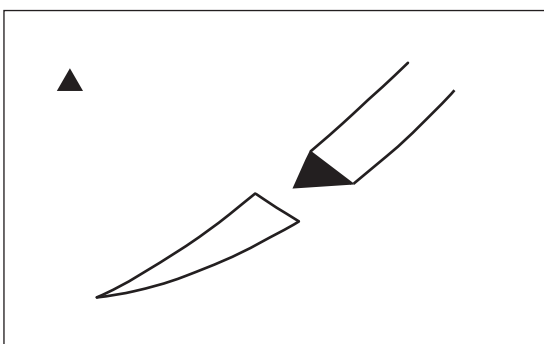
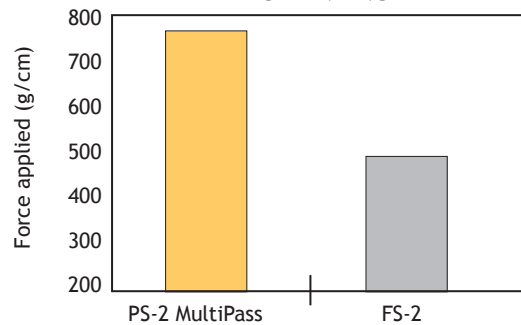

Cutting Needles for Skin Closure

Conventional Cutting Needle

This needle has a triangular cross section with the apex of the triangle on the inside of the needle curvature. The effective cutting edges are restricted to the front section of the needle and merge into a triangulated body which continues for half the length of the needle.

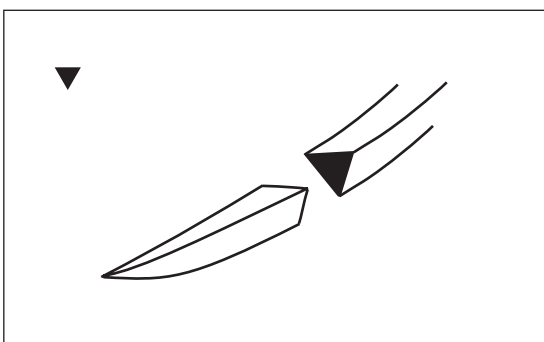

Reverse Cutting Needle

The body of this needle is triangular in cross section, having the apex cutting edge on the outside of the needle curvature. This improves the strength of the needle and particularly increases its resistance to bending.

Ophthalmic Needles

These fine needles are manufactured using a unique process which ensures extremely sharp cutting edges. The range includes spatulated designs for suturing specific layers of the eye in Anterior Segment surgery in addition to round bodied, cutting and TAPERCUT designs for specific ophthalmic and oculoplastic procedures.

CS-ULTIMA Spatula Needle

This needle represents a dramatic change in ophthalmic needle design. Its concave spatula geometry requires considerably less force to penetrate corneal scleral tissue than existing needles. This results in much less disruption of the of the cornea and the real possibility of reduced post-operative suture related astigmatism.

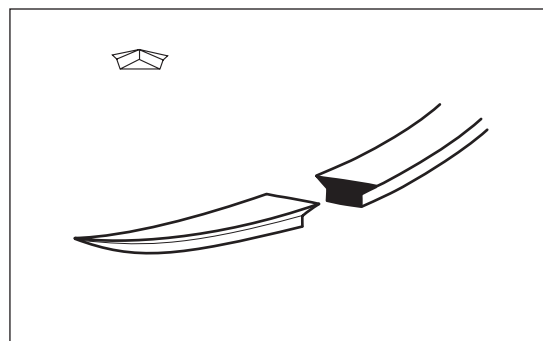

ADVANCED MICRO-POINT Spatula Needle

Due to the ultra fine diameter of this needle, a new concept of design has been necessary. An extremely sharp cutting point has been merged into a square body to produce superb penetration characteristics. In addition, the square body greatly increases resistance to bending and gives much improved needle holder security, locking the needle at the correct angle for secure accurate suture placement.

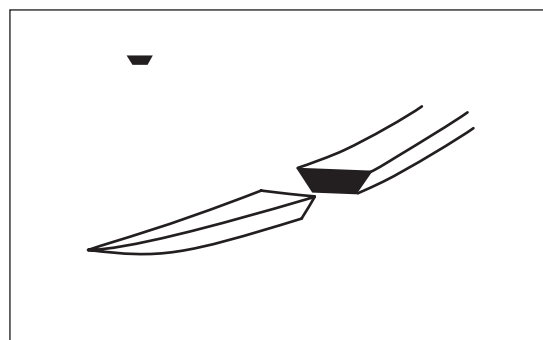

MICRO-POINT Spatula Needle

This needle has a thin, flat profile which allows the needle to penetrate between the layers of scleral or corneal tissue.

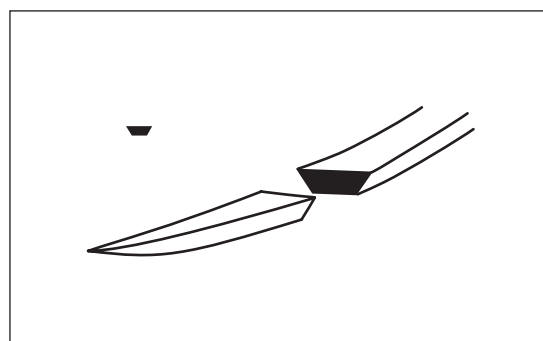

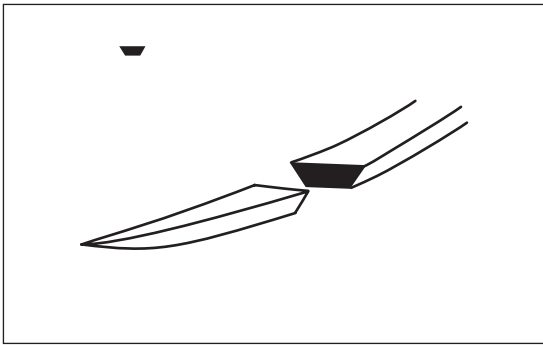

SPATULATED Needle

Similar in cross section to MICRO-POINT Spatula needles, this is designed for scleral suturing which requires stronger needles and where the elimination of cut out or cut down by a third edge is essential.

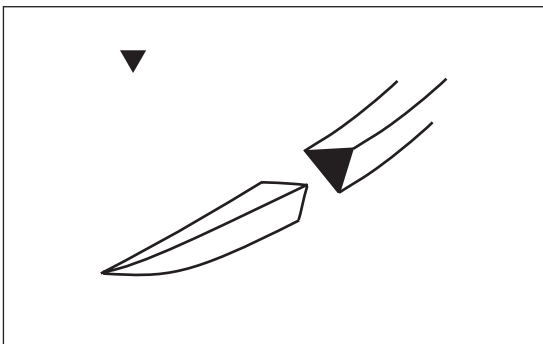

MICRO-POINT Reverse Cutting Needle

The third cutting edge of this needle lies on the outside of its curvature, thereby eliminating the possibility of needle cut out during suture placement.

CONTROL RELEASE Needle Sutures

1. The needle is held securely in the needle holder. Suture is grasped securely just below needle, pulling strand taut.

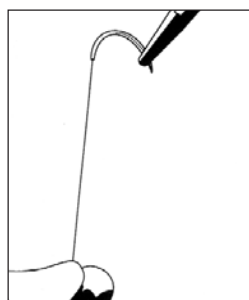



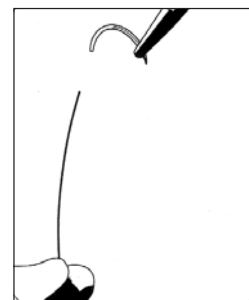



















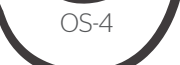









2. The needle is released with a straight tug of the needleholder.



































Ethicon Needle Sales Types





Cutting Edge











PRECISION POINT 		
Reverse Cutting		Conventional Cutting
3/8 Circle	1/2 Circle	3/8 Circle
 P-6  P-1  P-3  PS-3  PS-2  PS-1  PS  PSL  PSLX	 P-2  PS-6  PS-5  PS-4  PS-4c	 CPS-3  CR-1
REVERSE CUTTING 		
3/8 Circle		
 C-2  C-3  M-2  FS-3  FS-2  FS-1  FS  FSL  FSLX  LR  KP-3		
1/2 Circle		
 M-1  J-1  X-8  X-6  X-1  OS-2  OS-4  OS-6  OS-8  CP-2  CP-1  CP  CPX  CPXX  LS-1  LS		

MICRO-POINT® 		ULTIMA® 			
Reverse Cutting		Spatula			
3/8 Circle	1/2 Circle	1/8 Circle	1/4 Circle	3/8 Circle	1/2 Circle
 G-6	 G-7	 CS44-6	 CS90-6	 CS140-6	 CSM-6
 G-1	 G-2		 CS100-8	 CS140-8	 CS160-4
 G-3					 CS175-6
					 CS160-6
					 CS175-8

ULTIMA® 		SPATULA 			
Bi-Curve	Compound Curve	1/4 Circle	3/8 Circle	1/2 Circle	
 CS-B-6	 CS-C-6	 TG100-8	 VAS100-4	 TG140-8	 TG160-4-3M
		 CTC-6	 TGW140-4		 TG160-4
		 CTC-6L	 TG140-6		 TG160-6
					 OPS-5
					 TG160-8
					 TG175-8

SABERLOC® 					
Conventional Spatula		Spatula			Center Point Spatula
1/4 Circle	1/2 Circle	1/8 Circle	1/4 Circle	1/2 Circle	
 S-29	 S-28	 SM-1	 S-14	 S-22	 S-12
 S-4			 S-24	 S-2	
					 RD-1
Straight Transchamber		Bi-Curve			Compound Curve
 STC-6		 TG4-S	 TG6-S		 TG6-C

PRECISION COSMETIC 			
Conventional Cosmetic Prime®			
3/8 Circle		1/2 Circle	
 PC-1	 PC-3	 PC-5	 PC-12

STRAIGHT 	
 SC-1	 CCS-ST
 KS-1	 BN
 TS	 SK-3
 KS	 SKS-3
 SKS	

STERNUM ▾

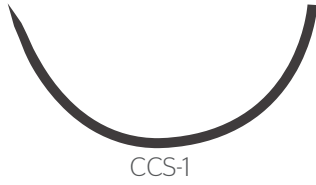
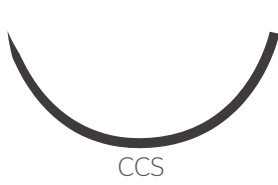

COMPOUND CURVE ▾



SKI ▾

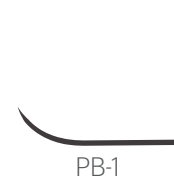

Taper Point



1/4 Circle



3/8 Circle

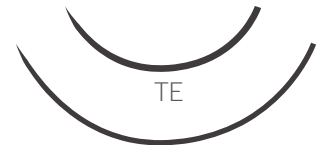

TE-1

5/8 Circle



UR-4

1/2 Circle

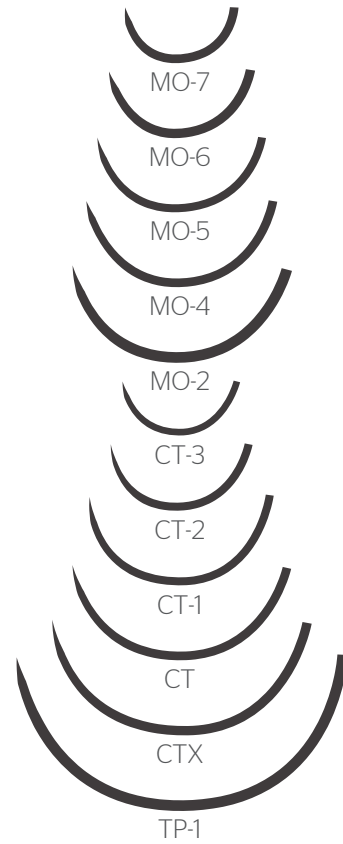
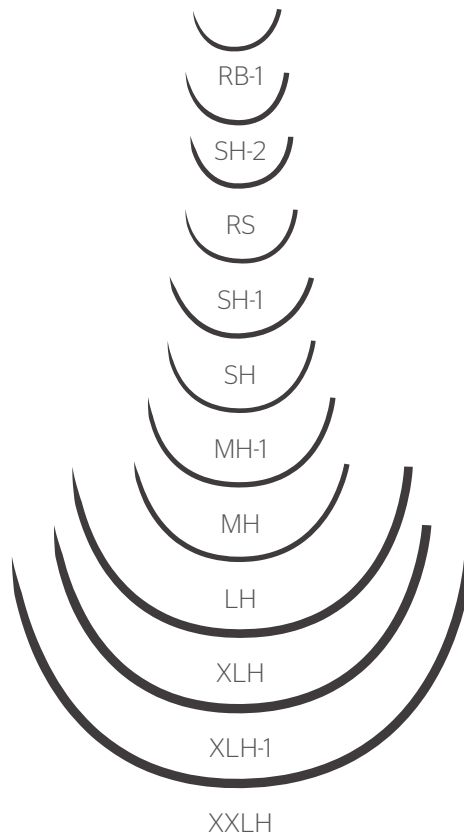

STRAIGHT ⊙

ST100-3

ST-1

ST-4

ST

ST-3

SKI ⊙

SIF-2

Tapercut®



3/8 Circle

1/4 Circle

Straight

1/2 Circle

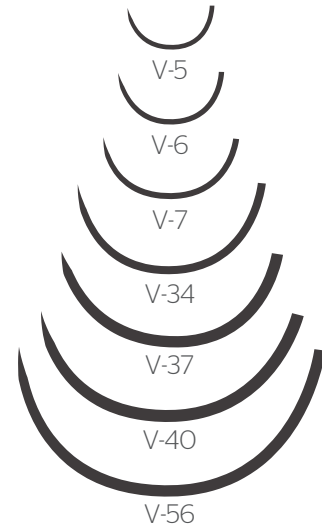
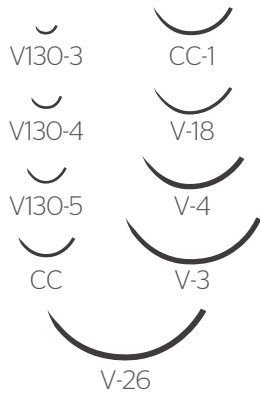

Trocar

STP-10

Blunt Point



1/2 Circle

Ethiguard®

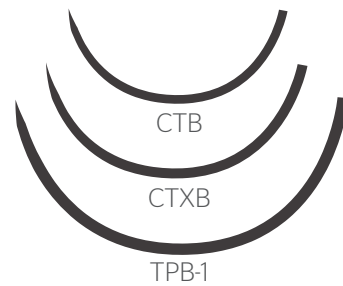
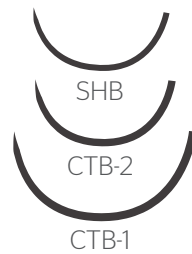
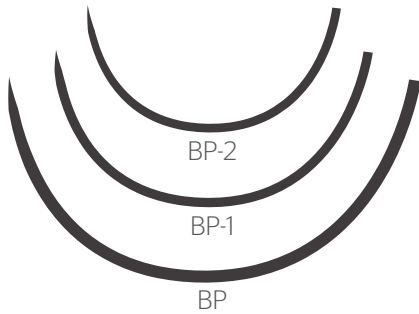

Endoscopy

Taperpoint ○

Tapercut® ▽



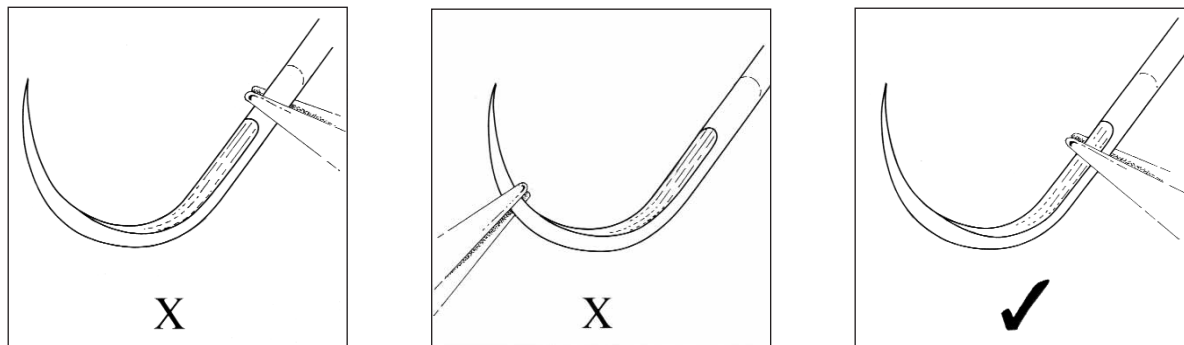













Use of Needle Holders

- 1 The needle holder should be carefully selected to match the size and strength of the needle to be used. The use of a needle holder larger than required can result in damage to the needle and in particular, distortion of the curvature.
- 2 The needle holder should be in good condition as worn jaws can result in needle rotation and instability in the needle holder. Nicks or defects in the needle holder jaws can also cause damage to the needle and loss of strength.
- 3 Needles should be grasped securely on the tip of the needle holder jaws.
- 4 Needles should only be held in the flattened area provided and should not be grasped on the attachment area or near to the needle point. Needles which are not flattened should be grasped for placement at a point approximately one third of the needle length from the butt. Excessive force should not be applied when gripping the needle, particularly with Tungsten Carbide jaw inserts, as this may damage the needle body and cause loss of strength or breakage.

Use of Surgical Needles

- 1 The force required to achieve passage of the needle through tissue should be applied in a direction following the curvature of the needle.
- 2 Care should be taken to match the size of the needle to the size of tissue bite required. The use of too small a needle for a given tissue bite can lead to bending.
- 3 Should the placement of the needle in tissue require to be readjusted, the needle should be removed and re-inserted. No attempt should be made to twist the needle in tissue.
- 4 The needles should normally be inserted separately into each side of the tissue to be approximated and should not be used to bridge a wound.

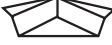
Needle Point Profiles

Needle Profile	New Graphic
Taper Point (Round Bodied)	
Taper Point Plus (modified point)	
ETHIGUARD Blunt Point Needle	
Blunt Point	
TAPERCUT Needle	
CC Needle	
TROCAR Point	
Conventional Cutting	
Reverse Cutting	
PRIME Needle Conventional Cutting	
PRIME Needle Reverse Cutting	
CS ULTIMA Spatula Needle	
Spatula	

	ABSORBABLE SUTURES	PHYSICAL CHARACTERISTICS	COLOR	REMAINING TENSILE STRENGTH (% of the original strength)					ABSORPTION RATE	KNOT TYING
				1 w.	2 w.	3 w.	4 w.	6 w.		
ABSORBABLE SUTURES	VICRYL® Rapide Polyglactin 910	Multifilament, coated	Violet Undyed	50% (5 days)	0% (10-14 days)				42 days	1=1=1=1
	MONOCRYL® Polyglactone 25	Monofilament	Violet Undyed	60% 50%	30% 20%			90 - 120 days	1=1=1=1**	
	MONOCRYL® Plus Antibacterial Polyglactone 25									
	VICRYL® (6-0 and larger*) Polyglactin 910	Multifilament, coated	Violet / Undyed		75 %	50 %	25 %	56 - 70 days	2=1=1 / 1=1=1=1	
	VICRYL® Plus Antibacterial Polyglactin 910									
	PDS®II (3-0 and larger*) Polydioxanone	Monofilament	Violet / Undyed		80 %		70 %	60 %	182 -238 days	1=1=1=1**
	PDS® Plus Antibacterial									
NON-ABSORBABLE SUTURES		PHYSICAL CHARACTERISTICS	COLOR						KNOT TYING	
NON-ABSORBABLE SUTURES	PROLENE® Polypropylene	Monofilament	Blue / Undyed						1=1=1=1/ 2=1=1**	
	PRONOVA® Poly(hexafluoropropylene-VDF)	Monofilament	Blue						1=1=1=1/ 2=1=1**	
	ETHIBOND® Polyester	Multifilament, coated	Green / White						2=1=1 / 1=1=1=1*	
	MERSILENE® Polyester	Multifilament	Green / White						2=1=1	
	ETHILON® Polyamide	Monofilament	Black / Blue						1=1=1=1/ 2=1=1**	
	NUROLON® Polyamide	Multifilament, coated	Black						2=1=1	
	SILK	Multifilament	Black/White/Blue						1=1=1=1	
	STEEL	Monofilament / Multifilament	Undyed						1=1=1=1	

* = Check the catalog for information on thinner sizes

** = Additional throws may be particularly appropriate when knotting any monofilament material

VICRYL* Rapide

(Polyglactin 910) Suture



VICRYL* Rapide (Polyglactin 910)

SUTURE

Description:	Braided	For easy handling and secure knot tying.
	Coated	For smooth passage through tissue and easy knot tie down.
	Synthetic	For minimal tissue reaction.
	Absorbable	By hydrolysis. Essentially complete in 42 days.

Tensile strength:	Post implantation	Approximate % original strength remaining
	5 days	50%
	10-14 days	0%

VICRYL* Rapide suture typically falls off 7-10 days post-operative or can be wiped off subsequently with gauze. Normally the removal of the suture is not required.

Color: Undyed or violet.

Range: 8-0 to 1 (USP). Supplied as needled sutures and ligatures.

Indications: VICRYL* Rapide is intended for use in soft tissue approximation where only short term wound support is required and where the rapid absorption of the suture would be beneficial. Typical areas of use include:



- Skin closure, cuticular or subcuticular
- Episiotomies
- Closure of oral mucosa
- Conjunctival sutures in ophthalmic surgery

Full details in the Instruction for Use included in every package.







VICRYL* Rapide (Polyglactin 910)

1/2 Circle Taper Point Needles

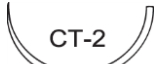
Needle	Gauge	Suture Color	Length (cm)	Other information	Number per box	Code
 RB-1 17 mm	5-0	UNDYED	70		36	V2130H
	4-0	UNDYED	70		36	V2140H
	3-0	UNDYED	70		36	V2150H
 SH-1 22 mm	4-0	UNDYED	70		36	V2180H
	3-0	UNDYED	70		36	V2190H
	2-0	UNDYED	70		36	V62H
 SH 26 mm	4-0	UNDYED	70		36	V4150H
	3-0	UNDYED	70		36	V4160H
	2-0	UNDYED	70		36	V4170H

1/2 Circle Taper Point Needles (Heavier Wire Diameter)

Needle	Gauge	Suture Color	Length (cm)	Other information	Number per box	Code
 CT-2 26 mm	2-0	UNDYED	70		36	V55H
 CT-1 36 mm	2-0	UNDYED	90		36	V9450H
	0	UNDYED	90		36	V9460H
	1	UNDYED	90		36	V70H
 CT 40 mm	0	UNDYED	90		36	V9580H
 CTX 48 mm	0	UNDYED	90		36	PN1695H

1/2 Circle ETHIGUARD* Blunt Point Needles





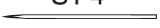

Needle	Gauge	Suture Color	Length (cm)	Other information	Number per box	Code
 CTB-1 36 mm	2-0	UNDYED	90		36	W9952H

VICRYL* Rapide (Polyglactin 910)

Straight Taper Point Needles



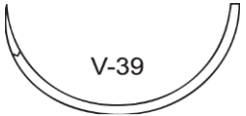

Needle	Gauge	Suture Color	Length (cm)	Other information	Number per box	Code
 ST-4	19 mm	4-0	UNDYED	70		36 BA1673H

1/2 Circle TAPERCUT* Needles

Needle	Gauge	Suture Color	Length (cm)	Other information	Number per box	Code
 V-5	17 mm	3-0	UNDYED	70		12 OA1674G
 V-7	26 mm	3-0	UNDYED	70		12 OB1674G
		3-0	UNDYED	70		36 OB1674H
 DA	26 mm	4-0	UNDYED	45	Compound curve	12 V2912G
 V-34	36 mm	2-0	UNDYED	90		36 V5170H
		0	UNDYED	90		36 V5180H
 V-39	45 mm	2-0	UNDYED	90		12 W9945
 V-40	48 mm	0	UNDYED	90		36 V7191H

VICRYL* Rapide (Polyglactin 910)

1/2 Circle Reverse Cutting Needles





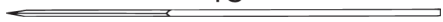
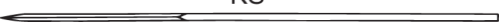

Needle	Gauge	Suture Color	Length (cm)	Other information	Number per box	Code
 J-1 17 mm	4-0	UNDYED	45		12	18510G
	4-0	UNDYED	45		36	V4550H
	3-0	UNDYED	45		36	V76H
 X-1 22 mm	3-0	UNDYED	45		36	V7902H
	2-0	UNDYED	45		36	V81H
 CP-1 36 mm	2-0	UNDYED	90		36	V4721H
 CP 40 mm	0	UNDYED	90		36	V4851H
	1	UNDYED	90		36	V4861H

Straight Cutting Needles

Needle	Gauge	Suture Color	Length (cm)	Other information	Number per box	Code
 TS 48 mm	3-0	UNDYED	75		36	VR2239
	2-0	UNDYED	75		36	VR2240
 KS 60 mm	3-0	UNDYED	70		36	AA1673H







VICRYL* Rapide (Polyglactin 910)

3/8 Circle Reverse Cutting PRIME* Needles

Needle	Gauge	Suture Color	Length (cm)	Other information	Number per box	Code
 P-1 11 mm	6-0	UNDYED	45	MULTIPASS*	36	MPVR9913H
	6-0	VIOLET	45		36	V32H
	6-0	UNDYED	45		12	W9913
	5-0	UNDYED	45	MULTIPASS*	36	MPVR9915H
	5-0	UNDYED	45		12	W9915
 P-3 13 mm	5-0	UNDYED	45	MULTIPASS*	36	MPVR4930H
	5-0	UNDYED	45		36	V4930H
	4-0	UNDYED	45	MULTIPASS*	36	MPVR4940H
	4-0	UNDYED	45		36	V4940H
 PS-4C 16 mm	4-0	UNDYED	45	COMPOUND CURVE	12	W9911
 PS-2 19 mm	4-0	UNDYED	45	MULTIPASS*	36	MPVR4960H
	4-0	UNDYED	75		12	W9922
	4-0	UNDYED	75	MULTIPASS*	36	MPVR4260H
	3-0	UNDYED	45		36	V4970H
	3-0	UNDYED	45	MULTIPASS*	36	MPVR4970H
	3-0	UNDYED	70	MULTIPASS*	36	MPVR4270H
	3-0	UNDYED	75		12	W9923
 PS-2 S 19 mm	4-0	UNDYED	45	Slimmed	36	V4960H
	4-0	UNDYED	70	Slimmed	36	V4260H
 PS-1 24 mm	3-0	UNDYED	45		36	V6830H
	3-0	UNDYED	70	MULTIPASS*	36	MPVR9360H
	3-0	UNDYED	70		36	V9360H
	2-0	UNDYED	70	MULTIPASS*	36	MPVR9380H
	2-0	UNDYED	70		36	V9380H

VICRYL* Rapide (Polyglactin 910)

3/8 Circle Reverse Cutting Needles

Needle	Gauge	Suture Color	Length (cm)	Other information	Number per box	Code
 C-3	13 mm	5-0	UNDYED	75		36 VR2289
 FS-2	19 mm	5-0	UNDYED	45		36 V2910H
		4-0	UNDYED	45		36 FH1642H
		4-0	UNDYED	75		12 W9930
		3-0	UNDYED	45		12 V2930G
		3-0	UNDYED	45		36 V2930H
 FS-2S	19 mm	4-0	UNDYED	45	Slimmed	36 V2920H
 FS-1	24 mm	3-0	UNDYED	45		36 V4421H
		3-0	UNDYED	70		36 V4420H
		2-0	UNDYED	45		36 V4431H
 FS	26 mm	3-0	UNDYED	75		12 W9940
		2-0	UNDYED	75		12 W9941
 FSL	30 mm	2-0	UNDYED	90		36 VR2286

3/8 Circle Conventional Cutting PRIME* Needles





Needle	Gauge	Suture Color	Length (cm)	Other information	Number per box	Code
 PC-3	16 mm	4-0	UNDYED	70	MULTIPASS*	36 MPVR9918H
		3-0	UNDYED	75		12 W9919

3/8 CIRCLE Taper Point needles

Needle	Gauge	Suture Color	Length (cm)	Other information	Number per box	Code
 BV-1	9,3 mm	8-0	VIOLET	30		12 W9916

VICRYL* Rapide (Polyglactin 910)

3/8 Circle MICROPPOINT* Spatula

Needle	Gauge	Suture Color	Length (cm)	Other information	Number per box	Code
GS-12 	5,5 mm	8-0	VIOLET	30		12 V1220G
GS-9 	6,5 mm	8-0	VIOLET	30		12 V1210G
		7-0	VIOLET	30		12 V1211G
GS-9 GS-9 	6,5 mm	8-0	VIOLET	30		12 V39G
		7-0	VIOLET	45		12 V38G
TG140-8 	6,5 mm	7-0	VIOLET	30		12 W9914

Ligatures

	Gauge	Suture Color	Length (cm)	Other information	Number per box	Code
SUTUPAK*	2-0	UNDYED	3x45		24	V8645E
SUTUPAK*	0	UNDYED	6x45		24	V8980E

MONOCRYL*

(Poliglecaprone 25) Suture



MONOCRYL*

(Poliglecaprone 25) Monofilament

SUTURE

Description: Monofilament For smooth passage through tissue.
Synthetic For minimal tissue reaction.
Absorbable By hydrolysis. Essentially complete in 90 -120 days.

Tensile strength: Post implantation Approximate % original strength remaining

7 days	60% (violet) 50% (undyed)
14 days	30% (violet) 20% (undyed)
21 days	0% (undyed)
28 days	0% (violet)

Color: Violet or undyed.

Range: 6-0 to 1 (USP). Supplied as needed sutures and ligatures.

Indications: MONOCRYL* sutures are intended for use in general soft tissue approximation and/or ligation where an absorbable material is indicated. Typical areas of use include:









- Subcuticular sutures
- Small intestine anastomoses
- Urological anastomoses

Full details in the Instruction for Use included in every package.



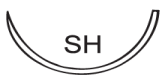

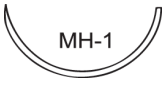
MONOCRYL* (Poliglecaprone 25) Monofilament Suture

1/2 Circle Taper Point Needles

Needle		Gauge	Suture Color	Length (cm)	Other information	Number per box	Code
 TF	13 mm	6-0	VIOLET	70		36	Y432H
		5-0	VIOLET	70		36	Y925H
 RB-1	17 mm	5-0	VIOLET	70		36	Y213H
		4-0	VIOLET	70		36	Y214H
		4-0	VIOLET	70	VISI-BLACK*	36	Y3040H
		3-0	UNDYED	70		36	T4215AH
		3-0	VIOLET	70		36	Y215H
 RB-1 RB-1	17 mm	5-0	VIOLET	90	VISI-BLACK*	36	C3060
		4-0	VIOLET	70	VISI-BLACK*	36	Y3214H
 SH-1	22 mm	4-0	VIOLET	70		36	Y218H
		4-0	VIOLET	70	VISI-BLACK*	36	Y3100H
		3-0	VIOLET	70		36	Y219H
		3-0	VIOLET	70	VISI-BLACK*	36	Y3110H
		2-0	VIOLET	70	VISI-BLACK*	36	Y3120H
 SH-1 SH-1	22 mm	4-0	VIOLET	70	VISI-BLACK*	36	Y3218H
		4-0	VIOLET	90	VISI-BLACK*	36	Y5218H
		3-0	VIOLET	70	VISI-BLACK*	36	Y3219H
 SH	26 mm	4-0	VIOLET	70		36	Y415H
		4-0	VIOLET	70	VISI-BLACK*	36	Y3150H
		3-0	UNDYED	70		12	NP0001
		3-0	VIOLET	70		36	Y416H
		3-0	VIOLET	70	VISI-BLACK*	36	Y3160H
		3-0	VIOLET	8x45 C/R	VISI-BLACK*	12	Y3864G
		3-0	VIOLET	8X70 C/R	VISI-BLACK*	12	Y7840G
		2-0	VIOLET	70		36	Y417H
		0	VIOLET	70		36	Y418H
		2-0	VIOLET	70	VISI-BLACK*	36	Y3170H
 SH SH	26 mm	3-0	VIOLET	70	VISI-BLACK*	36	Y3416H
		3-0	VIOLET	90	VISI-BLACK*	36	Y5270H
		2-0	VIOLET	70	VISI-BLACK*	36	Y3417H
 MH-1	31 mm	3-0	VIOLET	70		12	W3200
		2-0	VIOLET	70		12	W3441
 MH	36 mm	2-0	VIOLET	70		36	Y227H

MONOCRYL* (Poliglecaprone 25) Monofilament Suture



1/2 Circle Taper Point Needles (Heavier wire diameter)

Needle		Gauge	Suture Color	Length (cm)	Other information	Number per box	Code
 CT-2	26 mm	2-0	VIOLET	90		36	Y326H
		0	VIOLET	70		36	Y270H
 CT-1	36 mm	2-0	VIOLET	70		36	Y259H
		0	VIOLET	70		36	Y260H
		0	VIOLET	90		36	Y946H
		1	VIOLET	70		36	Y261H
 CTX	48 mm	2-0	VIOLET	90		12	Y979G
		1	VIOLET	90		12	Y977G

1/2 Circle ETHIGUARD* Blunt Point Needles

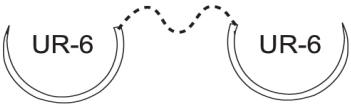

Needle		Gauge	Suture Color	Length (cm)	Other information	Number per box	Code
XLHD	70 mm	1	VIOLET	90		12	W3709

5/8 Circle Taper Point Needles



Needle		Gauge	Suture Color	Length (cm)	Other information	Number per box	Code
 UR-6	26 mm	3-0	VIOLET	70		12	W3625
		2-0	VIOLET	70		36	Y605H
 UR-6	26 mm	3-0	VIOLET	70		36	Y602H
 UR-5	36 mm	2-0	VIOLET	70		36	Y375H

MONOCRYL* (Poliglecaprone 25) Monofilament Suture





1/2 Circle TAPERCUT* Needles

Needle	Gauge	Suture Color	Length (cm)	Other information	Number per box	Code	
 DA-1	13 mm	5-0	UNDYED	45	Compound Curve	12	Y4950G
 V-7	26 mm	2-0	VIOLET	70		36	Y999H
 V-34	36 mm	2-0	VIOLET	70		12	W3488
		0	VIOLET	70		12	W3489
		1	VIOLET	90		36	Y919H

1/2 Circle Reverse Cutting Needles



Needle	Gauge	Suture Color	Length (cm)	Other information	Number per box	Code	
 X-1	22 mm	2-0	UNDYED	70		36	C459
 CP-2	26 mm	2-0	VIOLET	70		12	W3230
 CP-1	36 mm	0	UNDYED	70		36	C267

3/8 Circle Reverse Cutting PRIME* Needles



Needle	Gauge	Suture Color	Length (cm)	Other information	Number per box	Code	
 P-1	11 mm	6-0	UNDYED	45	MULTIPASS*	36	MPY489H
		6-0	UNDYED	45		36	Y489H
		5-0	UNDYED	45	MULTIPASS*	36	MPY490H
 P-3	13 mm	6-0	UNDYED	45	MULTIPASS*	36	MPY492H
		6-0	UNDYED	45		36	Y492H
		5-0	UNDYED	45	MULTIPASS*	36	MPY493H
		5-0	VIOLET	45		36	Y491H
		5-0	UNDYED	45		36	Y493H
		4-0	UNDYED	45	MULTIPASS*	36	MPY494H
		4-0	UNDYED	45		36	Y494H
 PS-3	16 mm	5-0	UNDYED	45	MULTIPASS*	36	MPY500H
		5-0	UNDYED	45		12	W3204
		4-0	UNDYED	45	MULTIPASS*	36	MPY501H
		4-0	UNDYED	45		12	W3205
 PS-4C	16 mm	5-0	UNDYED	45	Compound Curve	12	NP0127
		4-0	UNDYED	45	Compound Curve	12	NP0126

MONOCRYL* (Poliglecaprone 25) Monofilament Suture



3/8 Circle Reverse Cutting PRIME* Needles

Needle		Gauge	Suture Color	Length (cm)	Other information	Number per box	Code
 PS-2	19 mm	5-0	UNDYED	45	MULTIPASS*	36	MPY495H
		4-0	UNDYED	45	MULTIPASS*	36	MPY496H
		4-0	UNDYED	45		12	W3206
		4-0	UNDYED	70	MULTIPASS*	36	MPY426H
		3-0	UNDYED	45	MULTIPASS*	36	MPY497H
		3-0	UNDYED	45		12	W3207
		3-0	UNDYED	70		36	C427
		3-0	UNDYED	70	MULTIPASS*	36	MPY427H
 PS-1	24 mm	4-0	UNDYED	45		36	T4682H
		4-0	UNDYED	70	MULTIPASS*	36	MPY935H
		4-0	UNDYED	70		36	Y495H
		3-0	UNDYED	70		12	W3208
		3-0	UNDYED	70	MULTIPASS*	36	MPY683H
		2-0	UNDYED	70	MULTIPASS*	36	MPY684H
		2-0	UNDYED	70		36	Y684H
		 PS	26 mm	4-0	UNDYED	70	MULTIPASS*
4-0	UNDYED			70		12	W3212
3-0	UNDYED			70	MULTIPASS*	36	MPY3213H
3-0	UNDYED			70		12	W3213

3/8 Circle Reverse Cutting Needles

Needle		Gauge	Suture Color	Length (cm)	Other information	Number per box	Code
 FS-2	19 mm	4-0	UNDYED	45		36	Y292H
		4-0	UNDYED	70		36	Y422H
		3-0	UNDYED	45		36	Y293H
		3-0	UNDYED	70		36	Y423H
 FS-1	24 mm	4-0	UNDYED	70		36	Y291H
		3-0	UNDYED	70		36	Y442H
		2-0	UNDYED	70		36	Y443H
 FS	26 mm	3-0	UNDYED	70		12	W3326

Straight Cutting Needles

Needle		Gauge	Suture Color	Length (cm)	Other information	Number per box	Code
 TS	48 mm	4-0	UNDYED	70		36	C1041
 KS	60 mm	4-0	UNDYED	70		12	W3649
		3-0	UNDYED	70		12	W3650

MONOCRYL* (Poliglecaprone 25) Monofilament Suture

1/4 Circle Spatula Needles

Needle	Gauge	Suture Color	Length (cm)	Other information	Number per box	Code
 S-14 S-14	8 mm	6-0	UNDYED	45		12 W3552

Ligatures

	Gauge	Suture Color	Length (cm)	Other information	Number per box	Code
LIGAPAK*	3-0	VIOLET	250	Reel	10	W3020
SUTUPAK*	2-0	VIOLET	150		12	W3113
	1	VIOLET	150		12	W3115
	0	VIOLET	150		12	W3114
SUTUPAK*	2-0	VIOLET	2x70		36	Y625H
SUTUPAK*	3-0	UNDYED	3x45		36	Y634H

MONOCRYL* Plus

(Poliglecaprone 25) Antibacterial Suture



ETHICON
PART OF THE *Johnson & Johnson* FAMILY OF COMPANIES

MONOCRYL* Plus

(Poliglecaprone 25) Antibacterial

SUTURE

Description: **Monofilament** For smooth passage through tissue.
Synthetic For minimal tissue reaction.
Absorbable By hydrolysis. Essentially complete in 90 -120 days.

Tensile strength: **Post implantation** **Approximate % original strength remaining**

7 days	60% (violet) 50% (undyed)
14 days	30% (violet) 20% (undyed)
21 days	0% (undyed)
28 days	0% (violet)

Color: Violet or undyed.

Range: 6-0 to 1 (USP). Supplied as needled sutures and ligatures.

Indications: MONOCRYL* Plus sutures are intended for use in general soft tissue approximation and/or ligation where absorbable material is indicated. Typical areas of use include:

- Subcuticular sutures
- Small intestine anastomoses
- Urological anastomoses

Protection against bacterial colonization









In vitro studies demonstrate, that MONOCRYL* Plus suture has a zone of inhibition that is effective against the pathogens that most frequently cause surgical site infection, including *Staphylococcus aureus*, methicillin resistant *Staphylococcus aureus* (MRSA), *Staphylococcus epidermidis*, methicillin resistant *Staphylococcus epidermidis* (MRSE), *E. coli* and *Klebsiella pneumoniae*.

Full details in the Instruction for Use included in every package.

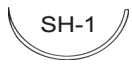

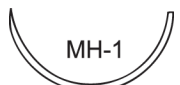

MONOCRYL* Plus (Poliglecaprone 25) Antibacterial Suture

1/2 Circle Taper Point Needles

Needle	Gauge	Suture Color	Length (cm)	Other information	Number per box	Code	
 TF	13 mm	5-0	VIOLET	70		36	MCP925H
 RB-1	5-0	VIOLET	70		36	MCP2131H	
	4-0	VIOLET	70		12	MCP3435G	
	3-0	VIOLET	70		36	MCP215H	
 RB-1 RB-1	4-0	VIOLET	90	VISI-BLACK*	36	MCP3070H	
 SH-1	4-0	VIOLET	70		36	MCP218H	
	4-0	VIOLET	70	VISI-BLACK*	36	MCP3100H	
	3-0	VIOLET	70		12	MCP219G	
	3-0	VIOLET	70	VISI-BLACK*	36	MCP3110H	
	2-0	VIOLET	70		36	MCP220H	
 SH-1 SH-1	4-0	VIOLET	70	VISI-BLACK*	36	MCP3218H	
	4-0	VIOLET	90	VISI-BLACK*	36	MCP5218H	
	3-0	VIOLET	70	VISI-BLACK*	36	MCP3219H	
 SH	4-0	VIOLET	70		36	MCP4150H	
	4-0	VIOLET	70	VISI-BLACK*	36	MCP3150H	
	3-0	VIOLET	70		36	MCP4160H	
	3-0	VIOLET	70	VISI-BLACK*	36	MCP3160H	
	2-0	VIOLET	70		36	MCP4170H	
	2-0	VIOLET	70	VISI-BLACK*	36	MCP3170H	
 SH SH	3-0	VIOLET	70		12	MCP3627G	
	3-0	VIOLET	90	VISI-BLACK*	36	MCP5270H	
 MH-1	31 mm	3-0	VIOLET	70		36	MCP3200H
 MH	36 mm	2-0	VIOLET	70		36	MCP227H

1/2 Circle Taper Point Needles (Heavier wire diameter)

Needle	Gauge	Suture Color	Length (cm)	Other information	Number per box	Code
 CT-2	2-0	VIOLET	70		36	MCP4269H
	0	VIOLET	90		36	MCP4330H
 CT-1	2-0	VIOLET	70		36	MCP4259H
	0	VIOLET	70		36	MCP260H
	0	VIOLET	90		36	MCP4946H
	0	UNDYED	90		36	MCP946H

MONOCRYL* Plus (Poliglecaprone 25) Antibacterial Suture







5/8 Circle Taper Point Needles

Needle		Gauge	Suture Color	Length (cm)	Other information	Number per box	Code
		3-0	VIOLET	70		36	MCP3625H
		2-0	VIOLET	70		36	MCP6050H

Compound Curve TAPERCUT* Needles



Needle		Gauge	Suture Color	Length (cm)	Other information	Number per box	Code
	13 mm	5-0	UNDYED	45	VISI-BLACK*	12	MCP4950G

3/8 Circle Reverse Cutting PRIME* Needles



Needle		Gauge	Suture Color	Length (cm)	Other information	Number per box	Code
	11 mm	6-0	UNDYED	70	MULTIPASS*	36	MCP489H
		5-0	UNDYED	70	MULTIPASS*	36	MCP490H
	13 mm	6-0	UNDYED	70	MULTIPASS*	36	MCP492H
		5-0	UNDYED	70	MULTIPASS*	36	MCP493H
		4-0	UNDYED	70	MULTIPASS*	36	MCP494H
	16 mm	5-0	UNDYED	70	MULTIPASS*	36	MCP500H
		4-0	UNDYED	70	MULTIPASS*	12	MCP3205G
	19 mm	5-0	UNDYED	70	MULTIPASS*	36	MCP495H
		4-0	UNDYED	45	MULTIPASS*	36	MCP496H
		4-0	UNDYED	70	MULTIPASS*	36	MCP4260H
		4-0	VIOLET	70	MULTIPASS*	36	MCP498H
		3-0	UNDYED	45	MULTIPASS*	36	MCP497H
		3-0	UNDYED	70	MULTIPASS*	36	MCP4271H
		3-0	VIOLET	70	MULTIPASS*	36	MCP428H
	24 mm	4-0	UNDYED	70	MULTIPASS*	36	MCP9350H
		3-0	UNDYED	70	MULTIPASS*	36	MCP683H
		2-0	UNDYED	70	MULTIPASS*	36	MCP684H
	26 mm	3-0	UNDYED	70	MULTIPASS*	36	MCP3213H

MONOCRYL* Plus (Poliglecaprone 25) Antibacterial Suture

3/8 Circle Reverse Cutting Needles

Needle		Gauge	Suture Color	Length (cm)	Other information	Number per box	Code
 FS-2	19 mm	5-0	UNDYED	70		12	MCP3209G
		4-0	UNDYED	45		36	MCP292H
		4-0	UNDYED	70		36	MCP4422H
		3-0	UNDYED	45		36	MCP293H
		3-0	UNDYED	70		36	MCP4423H
 FS-1	24 mm	4-0	UNDYED	70		36	MCP291H
		3-0	UNDYED	70		36	MCP442H
		2-0	UNDYED	70		36	MCP4443H
 FS	26 mm	3-0	UNDYED	70		12	MCP3326G

1/2 Circle Reverse Cutting Needles

Needle		Gauge	Suture Color	Length (cm)	Other information	Number per box	Code
 X-1	22 mm	2-0	UNDYED	70		36	MCP459H
 CP-1	36 mm	2-0	UNDYED	70		36	MCP2660H

Straight Cutting Needles

Needle		Gauge	Suture Color	Length (cm)	Other information	Number per box	Code
 KS	60 mm	4-0	UNDYED	70		12	MCP3649G
		3-0	UNDYED	70		12	MCP3650G

VICRYL*

(Polyglactin 910) Suture



VICRYL*

(Polyglactin 910) Braided and Monofilament

SUTURE

Description:	Braided	For easy handling and secure knot tying.
	Coated	For smooth passage through tissue and easy knot tie down.
	Synthetic	For minimal tissue reaction.
	Absorbable	By hydrolysis. Essentially complete in 56-70 days.

Tensile strength:	Post implantation	Approximate % original strength remaining
	14 days	75%
	21 days	50% (6-0 and larger)
	28 days	40% (7-0 and smaller) 25% (6-0 and larger)

Color: Violet or undyed.

Range: 10-0 to 6 (USP). Supplied as needled sutures and ligatures. Sizes 10-0 and 9-0 are monofilament in structure.

Indications: VICRYL* sutures are intended for use in soft tissue approximation and/or ligation, including use in ophthalmic surgery, peripheral nerve adaptation and microsurgery for vessels less than 2 mm in diameter. Typical areas of use include:







- Fascia closure - due to the 28-day claim
- Subcutaneous fat
- Joint capsule
- Uterus

Full details in the Instruction for Use included in every package.





VICRYL* (Polyglactin 910) Braided or Monofilament Suture

1/2 Circle Taper Point Needles

Needle		Gauge	Suture Color	Length (cm)	Other information	Number per box	Code
	6,5 mm	7-0	VIOLET	30		36	V1028H
	10 mm	5-0	VIOLET	70		36	V133H
	13 mm	6-0	VIOLET	70		36	PZ2571H
		6-0	UNDYED	45		12	W9981
		5-0	UNDYED	70	450 microns	36	V433H
	13 mm	6-0	VIOLET	70		36	V926H
		5-0	VIOLET	70	350 microns	36	V925H
		4-0	VIOLET	70		36	V924H
	17 mm	6-0	VIOLET	70		36	V302H
		5-0	VIOLET	70		36	V303H
		5-0	VIOLET	70	VISI-BLACK*	36	V3030H
		5-0	UNDYED	70		36	V213H
		4-0	VIOLET	70		36	V304H
		4-0	VIOLET	70	VISI-BLACK*	36	V3040H
		4-0	UNDYED	70		36	V214H
		4-0	VIOLET	8x45 C/R		12	V734D
		4-0	VIOLET	4x45 C/R		12	V735G
		4-0	VIOLET	8x70 C/R		12	V799D
		3-0	VIOLET	70		36	V305H
		3-0	UNDYED	70		36	V215H
		3-0	VIOLET	8x45 C/R		12	J713D
		2-0	VIOLET	70		36	V306H
	17 mm	3-0	VIOLET	70		36	V667H
	22 mm	4-0	VIOLET	70		36	V310H
		4-0	VIOLET	70	VISI-BLACK*	36	V3100H
		4-0	UNDYED	70		36	V426H
		3-0	VIOLET	70		36	V311H
		3-0	VIOLET	70	VISI-BLACK*	36	V3110H
		3-0	UNDYED	70		36	V219H
		3-0	VIOLET	4x45 C/R		36	V782H
		2-0	VIOLET	70		36	V312H
		2-0	VIOLET	70	VISI-BLACK*	36	V3120H
		2-0	UNDYED	70		36	V220H
		2-0	VIOLET	8x45 C/R		24	V792E



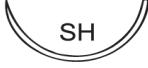
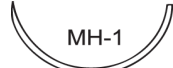
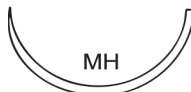





VICRYL* (Polyglactin 910) Braided or Monofilament Suture

1/2 Circle Taper Point Needles

Needle	Gauge	Suture Color	Length (cm)	Other information	Number per box	Code	
	26 mm	4-0	VIOLET	70		36	V315H
		4-0	VIOLET	70	VISI-BLACK*	36	V3150H
		4-0	VIOLET	8x70 C/R		12	V783G
		3-0	VIOLET	70		36	V316H
		3-0	VIOLET	70	VISI-BLACK*	36	V3160H
		3-0	UNDYED	70		36	V416H
		3-0	UNDYED	70	VISI-BLACK*	36	V4416H
		3-0	VIOLET	90		36	V242H
		3-0	VIOLET	8x45 C/R		12	J774D
		3-0	VIOLET	8x45 C/R	VISI-BLACK*	24	V7740E
		3-0	VIOLET	8X70 C/R	VISI-BLACK*	24	V7840E
		2-0	VIOLET	70		36	V317H
		2-0	VIOLET	70	VISI-BLACK*	36	V3170H
		2-0	UNDYED	70		36	V224H
		2-0	VIOLET	90		36	V243H
		2-0	VIOLET	4X45 C/R		36	V779H
		2-0	VIOLET	8x45 C/R		12	J775D
		0	VIOLET	70		36	V318H
		0	UNDYED	70		36	V225H
	31 mm	3-0	VIOLET	70		36	V245H
		2-0	VIOLET	70		36	V246H
		0	VIOLET	70		36	V247H
	36 mm	4-0	VIOLET	90		36	PG2592H
		3-0	VIOLET	70		36	V322H
		3-0	VIOLET	90		36	V100H
		2-0	VIOLET	70		36	V323H
		2-0	UNDYED	70		36	V226H
		2-0	VIOLET	90		36	V101H
		0	VIOLET	70		36	V324H
		0	VIOLET	90		36	V102H
		1	VIOLET	70		36	V325H
	40 mm	2-0	VIOLET	75		12	W9150

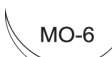

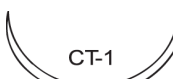

VICRYL* (Polyglactin 910) Braided or Monofilament Suture

1/2 Circle Taper Point Needles (Heavier wire diameter)

Needle	Gauge	Suture Color	Length (cm)	Other information	Number per box	Code	
 UCL	13 mm	3-0	VIOLET	70		36	V113H
		0	VIOLET	70		36	V115H
 UCLX	16 mm	3-0	VIOLET	70		36	V13H
		2-0	VIOLET	70		36	V14H
		0	VIOLET	70		36	V15H
		1	VIOLET	70		36	V16H
 CT-3	22 mm	3-0	VIOLET	70		36	V327H
		2-0	VIOLET	70		36	V328H
		0	VIOLET	70		36	V329H
 CT-2	26 mm	3-0	VIOLET	70		36	V332H
		2-0	VIOLET	70		36	V333H
		2-0	UNDYED	70		36	V269H
		2-0	VIOLET	4x45 C/R		24	V7642E
		0	VIOLET	70		36	V334H
		0	UNDYED	70		36	V270H
		0	VIOLET	8x45 C/R		24	V744E
		0	VIOLET	4x70 C/R		24	4PK2575YE
		1	VIOLET	70		36	V335H
2	VIOLET	70		36	V336H		
 MO-6	27 mm	1	VIOLET	90		36	V237H
 MO-5	31 mm	0	VIOLET	75		12	W9215
		1	VIOLET	75		12	W9216
 CT-1	36 mm	3-0	VIOLET	70		36	V338H
		3-0	UNDYED	90		36	V944H
		2-0	VIOLET	70		36	V339H
		2-0	VIOLET	90		36	V345H
		2-0	UNDYED	90		36	V945H
		2-0	UNDYED	8x70 C/R		12	JJ42D
		0	VIOLET	70		36	V340H
		0	VIOLET	90		36	V346H
		0	UNDYED	90		36	V946H
		0	VIOLET	8x45 C/R		12	J740D
		1	VIOLET	70		36	V341H
		1	VIOLET	90		36	V347H
		1	VIOLET	4x70 C/R		12	V736G
		2	VIOLET	90		36	V348H
2	UNDYED	90		36	V948H		
 MO-4	36 mm	0	VIOLET	70		36	V436H
		1	VIOLET	90		36	V255H





VICRYL* (Polyglactin 910) Braided or Monofilament Suture

1/2 Circle Taper Point Needles (Heavier wire diameter)

Needle	Gauge	Suture Color	Length (cm)	Other information	Number per box	Code	
 CT	40 mm	3-0	VIOLET	70		36	V350H
		2-0	VIOLET	70		36	V351H
		2-0	VIOLET	8x45 C/R		12	8PM2544YG
		0	VIOLET	70		36	V352H
		0	VIOLET	90		36	V358H
		1	VIOLET	70		36	V353H
		1	VIOLET	90		36	V359H
		1	VIOLET	8x45 C/R		12	J753D
		2	VIOLET	90		36	V360H
	2	UNDYED	90		36	V960H	
 MO-45	45 mm	0	VIOLET	75		12	W9244
		1	VIOLET	75		12	W9245
		2	VIOLET	75		12	W9246
 CTX	48 mm	3-0	VIOLET	70		36	V362H
		2-0	VIOLET	70		36	V363H
		0	VIOLET	70		36	V364H
		0	VIOLET	90		36	V370H
		0	UNDYED	90		36	V170H
		0	VIOLET	8x45 C/R		12	J764D
		1	VIOLET	70		36	V365H
		1	VIOLET	90		36	V371H
		1	UNDYED	90		36	V366H
		1	VIOLET	8x45 C/R		12	J765D
		2	VIOLET	90		36	V372H
		2	UNDYED	90		36	V367H
		 TP-1	65 mm	2	VIOLET	90	
 XLH	70 mm	2-0	VIOLET	70		12	V581G
		0	VIOLET	70		12	V582G

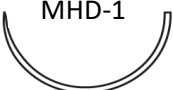
VICRYL* (Polyglactin 910) Braided or Monofilament Suture





1/2 Circle ETHIGUARD* Blunt Point Needles

Needle	Gauge	Suture Color	Length (cm)	Other information	Number per box	Code	
 MHD-1	31 mm	3-0	VIOLET	75		12	W9983
		2-0	VIOLET	75		12	W9984
 CTD-1	36 mm	2-0	VIOLET	75		12	W9985
		2-0	VIOLET	75	Heavy Needle	12	W9993
		0	VIOLET	75		12	W9986
		0	VIOLET	90	Heavy Needle	12	W9994
		1	VIOLET	90	Heavy Needle	12	W9995
 CTD	40 mm	0	VIOLET	75		12	W9988
		0	VIOLET	90	Heavy Needle	12	W9996
		1	VIOLET	90	Heavy Needle	12	W9997
 CTXD	48 mm	0	VIOLET	90		12	W9990
		1	VIOLET	90		12	W9991

3/8 Circle Blunt Point Needles

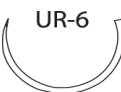

Needle	Gauge	Suture Color	Length (cm)	Other information	Number per box	Code	
 BP-5	65 mm	1	VIOLET	100		12	W9391

5/8 Circle Taper Point Needles





Needle	Gauge	Suture Color	Length (cm)	Other information	Number per box	Code	
 UR-6	26 mm	3-0	VIOLET	70		36	J601H
		2-0	VIOLET	70		36	V602H
		0	VIOLET	70		36	V603H
		1	VIOLET	70		36	VC2575H
 UR-6	26 mm	2-0	VIOLET	70		36	VCC2573H
 UR-5	36 mm	2-0	VIOLET	70		36	V375H
		0	VIOLET	70		36	V376H
		1	VIOLET	70		36	J377H
 UR-4	40 mm	2-0	VIOLET	70		36	V380H
		0	VIOLET	70		36	J381H

VICRYL* (Polyglactin 910) Braided or Monofilament Suture



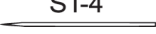

Fish Hook Needles

Needle	Gauge	Suture Color	Length (cm)	Other information	Number per box	Code	
 PB-30	30 mm	2-0	VIOLET	70	Taper point	36	DF2570H
 V-38	31 mm	1	VIOLET	75	TAPERCUT*	12	W9335

Straight Taper Point Needles



Needle	Gauge	Suture Color	Length (cm)	Other information	Number per box	Code	
 ST-4	19 mm	3-0	VIOLET	70		36	BA2574H
 ST-4	19 mm	4-0	VIOLET	35		36	V620H
 ST-4							
 ST	48 mm	2-0	VIOLET	90		36	V399H

1/2 Circle TAPERCUT* Needles



Needle	Gauge	Suture Color	Length (cm)	Other information	Number per box	Code	
 V-5	17 mm	4-0	VIOLET	70		12	V994G
		4-0	VIOLET	70		36	V994H
		4-0	UNDYED	70		36	V230H
		3-0	VIOLET	70		36	V276H
 V-6	22 mm	4-0	UNDYED	70		36	V231H
 V-7	26 mm	3-0	VIOLET	70		12	V998G
		3-0	VIOLET	70		36	V998H
		2-0	VIOLET	70		36	V999H
		2-0	VIOLET	6x45 C/R		24	6OB2545YE
		0	VIOLET	70		36	V279H
 V-30	31 mm	2-0	VIOLET	75		12	W9360
		0	VIOLET	75		12	W9361
		1	VIOLET	75		12	W9362
 V-34	36 mm	3-0	VIOLET	90		36	V516H
		2-0	VIOLET	90		36	V517H
		0	VIOLET	90		36	V518H
		1	VIOLET	90		36	V519H

VICRYL* (Polyglactin 910) Braided or Monofilament Suture



1/2 Circle TAPERCUT* Needles

Needle	Gauge	Suture Color	Length (cm)	Other information	Number per box	Code	
 V-37	40 MM	2-0	UNDYED	75	Slimmed	12	W9900
		2-0	UNDYED	75		12	W9904
		2-0	VIOLET	90		12	W9466
		0	VIOLET	90		36	VS4000H
 V-39	45 mm	0	VIOLET	75		12	W9376
		1	VIOLET	75		12	W9377
 V-40	48 mm	2-0	VIOLET	90		36	VS5020H
		1	VIOLET	150	Loop	24	V829E
		6	VIOLET	75		12	V140G

3/8 Circle TAPERCUT* Needles

Needle	Gauge	Suture Color	Length (cm)	Other information	Number per box	Code	
 CC-1	13 mm	6-0	UNDYED	45	MULTIPASS*	12	JV1727
 CC-1	13 mm	6-0	VIOLET	75		36	JV1012
		5-0	VIOLET	75		36	JV1013
 V-4	17 mm	5-0	UNDYED	75		12	W9824
		4-0	UNDYED	70		12	V240G
		3-0	UNDYED	75		12	W9826

5/8 Circle TAPERCUT* Needles







Needle	Gauge	Suture Color	Length (cm)	Other information	Number per box	Code	
 UV-10	10 mm	6-0	VIOLET	30		12	W9172
 UV-17	17 mm	4-0	UNDYED	75		12	W9820

VICRYL* (Polyglactin 910) Braided or Monofilament Suture

Compound Curve TAPERCUT* Needles



Needle	Gauge	Color	Length (cm)	Other information	Number per box	Code	
 DA	25 mm	4-0	VIOLET	45	VISI-BLACK*	12	18531G

1/2 Circle Reverse Cutting Needles









Needle	Gauge	Suture Color	Length (cm)	Other information	Number per box	Code	
 X-1	22 mm	3-0	VIOLET	70		36	V460H
		3-0	UNDYED	70		36	ME2673H
		2-0	VIOLET	70		36	V461H
		2-0	UNDYED	75		36	JV459
 OS-4	22 mm	0	UNDYED	70		36	J694H
		2	VIOLET	75		12	W9287
 CP-2	26 mm	3-0	VIOLET	70		36	MF2572H
		2-0	VIOLET	75		36	JV969
		2-0	UNDYED	70		36	V869H
		0	VIOLET	70		36	MF2574H
		0	VIOLET	4x45 C/R		24	V870E
		1	UNDYED	70		36	MF2675H
 CP-1	36 mm	3-0	VIOLET	70		36	V465H
		2-0	VIOLET	70		36	V466H
		2-0	VIOLET	90		36	V472H
		2-0	UNDYED	90		36	JV1472
		0	VIOLET	70		36	V467H
		0	VIOLET	90		36	V473H
		0	VIOLET	4x45 C/R		12	V475G
		1	VIOLET	70		36	V468H
		1	VIOLET	90		36	V474H
		2	VIOLET	90		36	V482H
 CP	40 mm	2-0	VIOLET	90		36	JV484
		0	VIOLET	70		36	V479H
		0	VIOLET	90		36	V485H
		1	VIOLET	70		36	V480H
		1	VIOLET	90		36	V486H
 CPX	48 mm	0	VIOLET	90		36	V1057H
		1	VIOLET	90		36	V1058H
		2	VIOLET	90		36	V1059H

VICRYL* (Polyglactin 910) Braided or Monofilament Suture

1/2 Circle Reverse Cutting PRIME* Needles







Needle	Gauge	Color	Length (cm)	Other information	Number per box	Code	
 P-2 P-2	8 mm	5-0	UNDYED	45		36	V505H
 PS-4	16 mm	5-0	UNDYED	45	Compound curve	12	W9436
		4-0	UNDYED	45		12	J507G
		4-0	UNDYED	45	Compound curve	12	W9437

3/8 Circle Reverse Cutting PRIME* Needles

Needle	Gauge	Suture Color	Length (cm)	Other information	Number per box	Code	
 P-1	11 mm	6-0	UNDYED	45	MULTIPASS*	36	MPV489H
		6-0	UNDYED	45		36	V489H
		5-0	UNDYED	45	MULTIPASS*	36	MPV490H
		5-0	UNDYED	45		36	V490H
 P-3	13 mm	6-0	UNDYED	45	MULTIPASS*	36	JV492H
		6-0	UNDYED	45		36	V492H
		5-0	UNDYED	45	MULTIPASS*	36	MPV493H
		5-0	UNDYED	45		36	V493H
		4-0	UNDYED	45	MULTIPASS*	36	MPV494H
		4-0	UNDYED	45		36	V494H
 PS-3	16 mm	5-0	UNDYED	45	MULTIPASS*	36	MPV500H
		4-0	UNDYED	45		24	W9506T
 PS-2	19 mm	5-0	UNDYED	45	MULTIPASS*	36	MPV495H
		4-0	UNDYED	45	MULTIPASS*	36	MPV496H
		4-0	UNDYED	45		24	W9515T
		3-0	UNDYED	45	MULTIPASS*	36	MPV497H
		3-0	UNDYED	45		36	V497H
 PS-2 S	19 mm	4-0	UNDYED	45	Slimmed	36	V496H
 PS-1	24 mm	4-0	UNDYED	70		36	JE2672H
		3-0	UNDYED	45	MULTIPASS*	36	MPV683H
		3-0	UNDYED	45		36	V683H
		2-0	UNDYED	45	MULTIPASS*	36	MPV684H
		2-0	UNDYED	45		36	V684H
 PS	26 mm	3-0	UNDYED	70	MULTIPASS*	36	MPV9526H
		2-0	UNDYED	75		24	W9527T
 PSL	30 mm	2-0	VIOLET	70		36	V686H

VICRYL* (Polyglactin 910) Braided or Monofilament Suture

3/8 Circle Reverse Cutting Needles



Needle	Gauge	Suture Color	Length (cm)	Other information	Number per box	Code	
	13 mm	6-0	VIOLET	45		36	J384H
		5-0	VIOLET	45		36	V385H
		4-0	VIOLET	45		36	V386H
	13 mm	4-0	VIOLET	45		12	JV559
	16 mm	6-0	VIOLET	45		36	V387H
		5-0	VIOLET	45		36	V388H
		4-0	VIOLET	75	CONV. CUTTING	12	W9443
	19 mm	5-0	UNDYED	45		36	V291H
		5-0	VIOLET	45		36	V391H
		5-0	UNDYED	70		36	V421H
		4-0	UNDYED	45		36	V292ZH
		4-0	VIOLET	45		12	V392ZG
		3-0	UNDYED	45		36	V293H
		3-0	VIOLET	45		12	V393G
		3-0	VIOLET	45		36	V393H
		3-0	UNDYED	70		36	V423H
		3-0	VIOLET	70		36	V398H
	19 mm	4-0	UNDYED	45	Slimmed	36	V292H
		4-0	VIOLET	45	Slimmed	36	V392H
		4-0	UNDYED	70	Slimmed	36	V422H
		4-0	VIOLET	70	Slimmed	36	V397H
	24 mm	4-0	UNDYED	70		36	V441H
		4-0	VIOLET	70		36	V451H
		3-0	UNDYED	70		36	V442H
		3-0	VIOLET	70		36	V452H
		2-0	UNDYED	70		36	V443H
		2-0	VIOLET	70		36	V453H
	30 mm	3-0	UNDYED	70		36	V588H
		3-0	VIOLET	70		36	V585H
		2-0	UNDYED	75		36	JV589
		2-0	VIOLET	70		36	V586H
		0	UNDYED	70		36	V520H
		0	VIOLET	70		36	V587H

VICRYL* (Polyglactin 910) Braided or Monofilament Suture

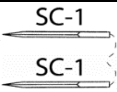

3/8 Circle Conventional Cutting PRIME* Needles

Needle		Gauge	Color	Length (cm)	Other information	Number per box	Code
 PC-3	16 mm	5-0	UNDYED	45		24	W9505T
		4-0	UNDYED	45	MULTIPASS*	36	MPV9506H
 PC-5	19 mm	4-0	UNDYED	75		24	W9570T
		3-0	UNDYED	75		24	W9571T
 PC-25	26 mm	4-0	UNDYED	70	MULTIPASS*	36	MPV9580H
		4-0	UNDYED	75		24	W9580T
		3-0	UNDYED	75		24	W9581T
 PCLX	36 mm	3-0	UNDYED	75		24	W9531T

Straight Cutting Needles



Needle		Gauge	Suture Color	Length (cm)	Other information	Number per box	Code
 SC-1	13 mm	4-0	VIOLET	45		36	V383H
		 KS	4-0	UNDYED	70		36
3-0	VIOLET		70		36	V523H	
3-0	UNDYED		70		36	V663H	
2-0	VIOLET		75		12	W9418	
2-0	UNDYED		75		12	W9718	

1/2 Circle MICROPPOINT* Spatula

Needle		Gauge	Color	Length (cm)	Other information	Number per box	Code
 GS-14 GS-14	5,5 mm	10-0	VIOLET	30		12	V450G
		9-0	VIOLET	30		12	V449G
		8-0	VIOLET	20		12	V574G
		7-0	VIOLET	30		36	ENN2534H
 TG175-8	7 mm	7-0	VIOLET	45		12	W9565

VICRYL* (Polyglactin 910) Braided or Monofilament Suture

3/8 Circle MICROPPOINT* Spatula

Needle	Gauge	Color	Length (cm)	Other information	Number per box	Code	
	6,5 mm	8-0	VIOLET	30		12	V120G
		7-0	VIOLET	30		12	V119G
	6,5 mm	10-0	VIOLET	30	Monofilament	12	V440G
		9-0	VIOLET	30		12	V549G
		9-0	VIOLET	30	Monofilament	12	V439G
		8-0	VIOLET	20		12	V547G
		8-0	VIOLET	30		12	V548G
		7-0	VIOLET	45		12	V546G
	6,6 mm	7-0	VIOLET	30		12	W9561

1/4 Circle MICROPPOINT* Spatula Needles

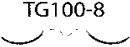
Needle	Gauge	Color	Length (cm)	Other information	Number per box	Code	
	6,5 mm	6-0	VIOLET	45		12	V544G

3/8 Circle MICROPPOINT* Reverse Cutting Needles

Needle	Gauge	Color	Length (cm)	Other information	Number per box	Code	
	6,2 mm	10-0	VIOLET	30	Monofilament	12	EMM2830G
	8 mm	7-0	VIOLET	30		36	EA2531H
	8 mm	6-0	VIOLET	45		12	V551G
	11 mm	6-0	VIOLET	45		12	W9537
	13 mm	5-0	VIOLET	45		12	V557G

VICRYL* (Polyglactin 910) Braided or Monofilament Suture

3/8 Circle CS ULTIMA* Spatula

Needle	Gauge	Color	Length (cm)	Other information	Number per box	Code
CS-140-6 	6,2 mm 10-0	VIOLET	15		12	V429G

1/8 Circle CS ULTIMA* Spatula

Needle	Gauge	Color	Length (cm)	Other information	Number per box	Code
CS44-6 	6,5 mm 10-0	VIOLET	10	Monofilament	12	V965



3/8 Circle Spatula Needles

Needle	Gauge	Color	Length (cm)	Other information	Number per box	Code
SPAT-10 	11 mm	5-0	45	UNDYED	12	W9761
		4-0	45	UNDYED	12	W9762

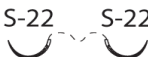
1/2 Circle Spatula Needles



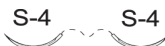

Needle	Gauge	Color	Length (cm)	Other information	Number per box	Code
S-22 S-22 	8 mm	6-0	45	VIOLET	12	W9566
		6-0	45	UNDYED	12	W9756
		5-0	45	VIOLET	12	W9567

1/4 Circle Spatula Needles

Needle	Gauge	Suture Color	Length (cm)	Other information	Number per box	Code	
S-4 S-4 	8 mm	4-0	45	VIOLET	12	V572G	
S-29 S-29 	8 mm	6-0	45	VIOLET	12	J555G	
S-14 S-14 	8 mm	6-0	45	VIOLET	12	V570G	
		6-0	45	VIOLET	VISI-BLACK*	12	V575G
		6-0	45	UNDYED		12	V670G
		6-0	20	VIOLET		12	W9562
		5-0	45	VIOLET		12	V571G
		5-0	45	UNDYED	12	V671G	

VICRYL* (Polyglactin 910) Braided or Monofilament Suture

3/8 Circle Taper Point Needles

Needle		Gauge	Color	Length (cm)	Other information	Number per box	Code
BV-6 	4,8 mm	10-0	VIOLET	10	Monofilament	12	V970G
BV-4 	4,9 mm	10-0	VIOLET	15	Monofilament	12	V971G
BV130-5 	6,5 mm	9-0	VIOLET	15	Monofilament	12	V239G
		8-0	VIOLET	20		12	V400G
BV-1 	9,3 mm	8-0	VIOLET	30		12	W9577
		6-0	VIOLET	30		12	W9575
BB 	17 mm	4-0	VIOLET	75	VISI-BLACK*	36	JV2024
		3-0	VIOLET	75	VISI-BLACK*	36	JV2025

VICRYL* (Polyglactin 910) Braided or Monofilament Suture

Ligatures

	Gauge	Suture Color	Length (cm)	Other information	Number per box	Code
LIGAPAK*	4-0	VIOLET	250	Reel	12	V1204G
	3-0	VIOLET	250	Reel	12	V1205G
	2-0	VIOLET	250	Reel	12	V1206G
	0	VIOLET	250	Reel	12	V1207G
	1	VIOLET	250	Reel	12	V1208G
	4-0	VIOLET	125	Reel	12	V204G
	3-0	VIOLET	125	Reel	12	V205G
	2-0	VIOLET	125	Reel	12	V206G
	0	VIOLET	125	Reel	12	V207G
SUTUPAK*	3-0	VIOLET	140		36	V614H
	2-0	VIOLET	140		36	V615H
	0	VIOLET	140		36	V616H
	1	VIOLET	140		36	V617H
	2	VIOLET	140		36	V618H
SUTUPAK*	4-0	VIOLET	2x70		24	V623E
	3-0	VIOLET	2x70		24	V624E
	2-0	VIOLET	2x70		24	V625E
	0	VIOLET	2x70		24	V626E
	1	VIOLET	2x70		36	V627H
	2	VIOLET	2x70		36	V628H
SUTUPAK*	5-0	VIOLET	3x45		36	V632H
	5-0	UNDYED	3x45		36	V642H
	4-0	VIOLET	3x45		36	V633H
	4-0	UNDYED	3x45		36	V643H
	3-0	VIOLET	3x45		36	V634H
	3-0	UNDYED	3x45		36	V644H
	2-0	VIOLET	3x45		36	V635H
	2-0	UNDYED	3x45		36	V645H
	0	VIOLET	3x45		24	V636E
	1	VIOLET	3x45		24	V637E
	2	VIOLET	3x45		36	V638H
SUTUPAK*	4-0	VIOLET	5x70		24	V1214E
	3-0	VIOLET	5x70		24	V1215E
	3-0	UNDYED	5x70		24	V963E
	2-0	VIOLET	5x70		24	V1216E
	2-0	UNDYED	5x70		25	V964E
	0	VIOLET	5x70		24	V1217E
	0	UNDYED	5x70		24	V965E
	1	VIOLET	5x70		36	V1218H
	2	VIOLET	5x70		36	V1219H
SUTUPAK*	5-0	VIOLET	6x45		36	V1223H
	4-0	VIOLET	6x45		36	V1224H
	3-0	VIOLET	6x45		36	V1225H
	3-0	UNDYED	6x45		36	V978H
	2-0	VIOLET	6x45		36	V1226H
	0	VIOLET	6x45		24	V1227E
	1	VIOLET	6x45		24	V1228E
	2	VIOLET	6x45		36	V1229H

VICRYL* (Polyglactin 910) Braided or Monofilament Suture

Ligatures

	Gauge	Suture Color	Length (cm)	Other information	Number per box	Code
SUTUPAK*	4-0	VIOLET	12x45		36	V903H
	3-0	VIOLET	12x45		36	V904H
	3-0	UNDYED	12x45		36	V910H
	2-0	VIOLET	12x45		24	V905E
	2-0	UNDYED	12x45		24	V911E
	0	VIOLET	12x45		24	V906E
	0	UNDYED	12x45		24	V912E
	1	VIOLET	12x45		24	V907E

VICRYL* Plus

(Polyglactin 910) Antibacterial Suture



VICRYL* Plus

(Polyglactin 910) Braided Antibacterial

SUTURE

Description:	Braided	For easy handling and secure knot tying.
	Coated	For smooth passage through tissue and easy knot tie down.
	Synthetic	For minimal tissue reaction.
	Absorbable	By hydrolysis. Essentially complete in 56-70 days.

Tensile strength: Post implantation

	Approximate % of original strength remaining
14 days	75%
21 days	50%
28 days	25%

Color: Violet or undyed.

Range: 5-0 to 2 (USP). Supplied as needled sutures and ligatures.

Indications: VICRYL* Plus sutures are intended for use in soft tissue approximation and/or ligation, including use in microsurgery for vessels less than 2 mm in diameter. The safety and effectiveness of VICRYL* Plus sutures in cardiovascular tissue, ophthalmic surgery and neurological tissue have not been established. Typical areas of use include:

- Fascia closure - due to the 28-day claim
- Subcutaneous fat
- Joint capsule
- Uterus

Protection against bacterial colonization







In vitro studies demonstrate, that VICRYL* Plus suture has a zone of inhibition that is effective against the pathogens that most frequently cause surgical site infection, including *Staphylococcus aureus*, methicillin resistant *Staphylococcus aureus* (MRSA), *Staphylococcus epidermidis* and methicillin resistant *Staphylococcus epidermidis* (MRSE).

Full details in the Instruction for Use included in every package.



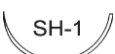

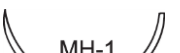



VICRYL* Plus (Polyglactin 910) Antibacterial Multifilament

1/2 Circle Taper Point Needles

Needle	Gauge	Suture Color	Length (cm)	Other information	Number per box	Code	
 RB-2	13 mm	4-0	UNDYED	70	450 microns	36	VCP434H
 TF	13 mm	5-0	VIOLET	70	350 microns	36	VCP925H
		4-0	VIOLET	70	450 microns	36	VCP924H
 RB-1	17 mm	5-0	VIOLET	70		36	VCP303H
		4-0	VIOLET	70		36	VCP304H
		4-0	UNDYED	70		36	VCP214H
		3-0	VIOLET	70		36	VCP305H
		3-0	UNDYED	70		36	VCP215H
		2-0	VIOLET	70		36	VCP306H
 SH-1	22 mm	4-0	VIOLET	70		36	VCP310H
		4-0	UNDYED	70		36	VCPV426H
		4-0	VIOLET	70	VISI-BLACK*	36	VCP3100H
		4-0	VIOLET	8x45 C/R*		12	VCP794D
		3-0	VIOLET	70		36	VCP311H
		3-0	VIOLET	70	VISI-BLACK*	36	VCP3110H
		3-0	UNDYED	70		36	VCP219H
		3-0	VIOLET	4x45 C/R*		36	VCP782H
		2-0	VIOLET	70		36	VCP312H
2-0	UNDYED	70		36	VCP220H		
 SH	26 mm	4-0	VIOLET	70		36	VCP315H
		3-0	VIOLET	70		36	VCP316H
		3-0	VIOLET	70	VISI-BLACK*	36	VCP3160H
		3-0	UNDYED	70		36	VCP416H
		3-0	VIOLET	90		36	VCP242H
		3-0	VIOLET	8x70 C/R*		24	VCP784E
		3-0	VIOLET	8x45 C/R*	VISI-BLACK*	24	VCP7740E
		3-0	VIOLET	8x70 C/R*	VISI-BLACK*	24	VCP7840E
		2-0	VIOLET	70		36	VCP317H
		2-0	VIOLET	70	VISI-BLACK*	36	VCP3170H
		2-0	UNDYED	70		36	VCP224H
		2-0	VIOLET	90		36	VCP243H
		2-0	VIOLET	8x45 C/R*	VISI-BLACK*	24	VCP7750E
0	VIOLET	70		36	VCP318H		
 MH-1	31 mm	3-0	VIOLET	70		36	VCP245H
		2-0	VIOLET	70		36	VCP246H
		0	VIOLET	70		36	VCP247H
 MH	36 mm	3-0	VIOLET	70		36	VCP322H
		3-0	VIOLET	90		36	VCP100H
		2-0	VIOLET	70		36	VCP323H
		0	VIOLET	70		36	VCP324H
		0	VIOLET	90		36	VCP102H
		1	VIOLET	70		36	VCP325H





VICRYL* Plus (Polyglactin 910) Antibacterial Multifilament

1/2 Circle Taper Point Needles (Heavier Wire Diameter)

Needle	Gauge	Suture Color	Length (cm)	Other information	Number per box	Code	
 UCLX	16 mm	2-0	VIOLET	70		36	VCP14H
		0	VIOLET	70		36	VCP15H
 MO-7	22 mm	1	VIOLET	70		36	VCP250H
		2	VIOLET	70		36	VCP251H
 CT-3	22 mm	3-0	VIOLET	70		36	VCPV327H
		2-0	VIOLET	70		36	VCP328H
		0	VIOLET	70		36	VCP329H
 CT-2	26 mm	3-0	VIOLET	70		36	VCPV332H
		2-0	VIOLET	70		36	VCP333H
		2-0	VIOLET	90		36	VCP326H
		2-0	UNDYED	70		36	VCPV269H
		0	VIOLET	70		36	VCP334H
		0	UNDYED	70		36	VCP270H
		0	VIOLET	90		36	VCP330H
		0	VIOLET	8x45 C/R*		24	VCP744E
		1	VIOLET	70		36	VCP335H
2	VIOLET	70		36	VCP336H		
 MO-5	31 mm	0	VIOLET	70		36	VCP9215H
		1	VIOLET	90		36	VCP253H
 CT-1	36 mm	3-0	VIOLET	70		36	VCP338H
		3-0	UNDYED	90		36	VCPV944H
		2-0	VIOLET	70		36	VCP339H
		2-0	VIOLET	90		36	VCP345H
		2-0	UNDYED	90		36	VCP945H
		0	VIOLET	70		36	VCP340H
		0	VIOLET	90		36	VCP346H
		0	UNDYED	90		36	VCP946H
		0	VIOLET	8x45 C/R*		12	VCP740G
		1	VIOLET	70		36	VCP341H
		1	VIOLET	90		36	VCP347H
		1	UNDYED	90		36	VCP947H
		1	VIOLET	4x70 C/R*		12	VCP736G
		1	VIOLET	8x45 C/R*		12	VCP741G
		2	VIOLET	90		36	VCP348H
2	VIOLET	4x70 C/R*		12	VCP737G		
2	VIOLET	8x45 C/R*		12	VCP742G		
 MO-4	36 mm	1	VIOLET	90		36	VCP437H
		2	VIOLET	90		36	VCP438H



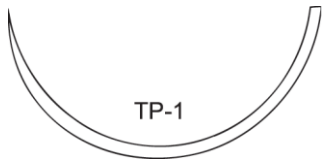

VICRYL* Plus (Polyglactin 910) Antibacterial Multifilament

1/2 Circle Taper Point Needles (Heavier Wire Diameter)



Needle	Gauge	Suture Color	Length (cm)	Other information	Number per box	Code	
 <p>CT</p>	40 mm	3-0	VIOLET	70		36	VCPV350H
		2-0	VIOLET	70		36	VCP351H
		0	VIOLET	70		36	VCP352H
		0	VIOLET	90		36	VCP358H
		1	VIOLET	70		36	VCP353H
		1	VIOLET	90		36	VCP359H
		1	VIOLET	8x45 C/R*		12	VCP753G
		2	VIOLET	90		36	VCP360H
		2	VIOLET	8x45 C/R*		12	VCP754G
 <p>MO-45</p>	45 mm	1	VIOLET	70		36	VCP9245H
		2	VIOLET	70		36	VCP9246H
 <p>CTX</p>	48 mm	2-0	VIOLET	70		36	VCP363H
		0	VIOLET	90		36	VCP370H
		0	VIOLET	8x45 C/R*		12	VCPN2545G
		1	VIOLET	70		36	VCP365H
		1	VIOLET	90		36	VCP371H
		1	UNDYED	90		36	VCP366H
		1	VIOLET	8x45 C/R*		12	VCP765G
		2	VIOLET	90		36	VCP372H
		2	UNDYED	90		36	VCP367H
 <p>TP-1</p>	65 mm	2	VIOLET	4x70		6	VCP649
 <p>XLH</p>	70 mm	2-0	VIOLET	70		12	VCP581G
		1	VIOLET	90		12	VCP5891G

VICRYL* Plus (Polyglactin 910) Antibacterial Multifilament

1/2 Circle ETHIGUARD* Blunt Point Needles



Needle		Gauge	Suture Color	Length (cm)	Other information	Number per box	Code
 CTD-1	36 mm	1	VIOLET	90		36	VCP9995H
 CTD	40 mm	0	VIOLET	90		24	VCP9996E
		1	VIOLET	90		24	VCP9997E
 TD-3	45 mm	2	VIOLET	90		36	VCP9999H
 CTXD	48 mm	1	VIOLET	90		24	VCP9991E

5/8 Circle Taper Point Needles







Needle		Gauge	Suture Color	Length (cm)	Other information	Number per box	Code
 UR-6	26 mm	2-0	VIOLET	70		36	VCP602H
		0	VIOLET	70		36	VCP603H
 MF	31 mm	3-0	UNDYED	70		36	VCP308H
 UR-5	36 mm	2-0	VIOLET	70		36	VCP375H
		0	VIOLET	70		36	VCP376H

VICRYL* Plus (Polyglactin 910) Antibacterial Multifilament

Fish Hook Needles

Needle	Gauge	Suture Color	Length (cm)	Other information	Number per box	Code	
 <p>V-38</p>	31 mm	1	VIOLET	70	TAPERCUT*	36	VCP9335H
 <p>ASH-35</p>	35 mm	0	VIOLET	70		36	VCP9221H

1/2 Circle TAPERCUT* Needles

Needle	Gauge	Suture Color	Length (cm)	Other information	Number per box	Code	
 <p>V-5</p>	17 mm	4-0	VIOLET	70		36	VCP994H
		3-0	VIOLET	70		36	VCP276H
		1	VIOLET	70		36	VCP988H
 <p>V-6</p>	22 mm	2-0	VIOLET	70		36	VCP278H
 <p>V-7</p>	26 mm	3-0	VIOLET	70		36	VCP998H
		2-0	VIOLET	70		36	VCP999H
		0	VIOLET	70		36	VCP279H
 <p>V-30</p>	31 mm	2-0	VIOLET	70		36	VCP9360H
		0	VIOLET	70		36	VCP9361H
 <p>V-34</p>	36 mm	3-0	VIOLET	90		36	VCP516H
		2-0	VIOLET	90		36	VCP517H
		0	VIOLET	90		36	VCP518H
		1	VIOLET	90		36	VCP519H
		2	VIOLET	90		36	VCP520H
 <p>V-37</p>	40 mm	0	UNDYED	70		36	VCP9901H
		0	VIOLET	90		36	VCPW9467H

VICRYL* Plus (Polyglactin 910) Antibacterial Multifilament



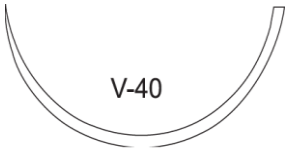

1/2 Circle TAPERCUT* Needles

Needle	Gauge	Suture Color	Length (cm)	Other information	Number per box	Code	
 V-39	45 mm	1	VIOLET	70		36	VCP9377H
 V-40	48 mm	2-0	VIOLET	90		36	VCP5020H
		1	VIOLET	150	LOOP	24	VCP829E

3/8 Circle TAPERCUT* Needles

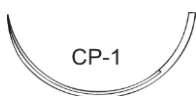

Needle	Gauge	Suture Color	Length (cm)	Other information	Number per box	Code	
 V-4	17 mm	4-0	UNDYED	70		36	VCP240H

1/2 Circle Reverse Cutting Needles (Heavier Wire Diameter)





Needle	Gauge	Suture Color	Length (cm)	Other information	Number per box	Code	
 J-1	17 mm	4-0	VIOLET	75		36	VCPJV457H
 X-1	22 mm	3-0	VIOLET	45		36	VCP460H
		3-0	UNDYED	70		36	VCP458H
		2-0	UNDYED	70		36	VCP459H
 OS-4	22 mm	0	UNDYED	70	Heavy Needle	36	VCP694H
		1	UNDYED	70	Heavy Needle	36	VCP695H
		2	VIOLET	70	Heavy Needle	36	VCP9287H
 CP-2	26 mm	2-0	VIOLET	70		36	VCP969H
		0	VIOLET	70		36	VCP974H
 CP-1	36 mm	2-0	VIOLET	70		36	VCP466H
		2-0	UNDYED	90		36	VCP1472H
		0	VIOLET	70		36	VCP467H
		0	VIOLET	90		36	VCP473H
		1	VIOLET	70		36	VCP468H
		1	VIOLET	90		36	VCP474H
		2	VIOLET	90		36	VCP482H

VICRYL* Plus (Polyglactin 910) Antibacterial Multifilament

1/2 Circle Reverse Cutting Needles (Heavier Wire Diameter)





Needle		Gauge	Suture Color	Length (cm)	Other information	Number per box	Code
 CP	40 mm	2-0	VIOLET	90		36	VCPJV484H
		0	VIOLET	70		36	VCP479H
		0	VIOLET	90		36	VCP485H
		1	VIOLET	70		36	VCP480H
		1	VIOLET	90		36	VCP486H
 CPX	48 mm	0	VIOLET	70		36	VCP9295H
		1	VIOLET	90		36	VCP1058H
		2	VIOLET	90		36	VCP1059H

3/8 Circle Reverse Cutting PRIME* Needles



Needle		Gauge	Suture Color	Length (cm)	Other information	Number per box	Code
 P-3	13 mm	5-0	UNDYED	45	MULTIPASS*	36	MPVCP493H
		5-0	UNDYED	45		36	VCP493H
		4-0	UNDYED	45	MULTIPASS*	36	MPVCP494H
		4-0	UNDYED	45		36	VCP494H
 PS-3	16 mm	5-0	UNDYED	45	MULTIPASS*	36	MPVCP500H
		5-0	UNDYED	45		36	VCP500H
 PS-2	19 mm	4-0	UNDYED	45	MULTIPASS*	36	MPVCP496H
		4-0	UNDYED	45		36	VCP496ZH
		3-0	UNDYED	45	MULTIPASS*	36	MPVCP497H
		3-0	UNDYED	45		36	VCP497H
 PS-2 S	19 mm	4-0	UNDYED	45	Slimmed	36	VCP496H
 PS-1	24 mm	3-0	UNDYED	45		36	VCP683H
		3-0	UNDYED	45	MULTIPASS*	36	MPVCP683H
		2-0	UNDYED	45		36	VCP684H

VICRYL* Plus (Polyglactin 910) Antibacterial Multifilament

3/8 Circle Reverse Cutting Needles

Needle		Gauge	Suture Color	Length (cm)	Other information	Number per box	Code
	19 mm	5-0	UNDYED	45		36	VCP291H
		5-0	VIOLET	45		36	VCP391H
		4-0	UNDYED	45		36	VCP292ZH
		4-0	VIOLET	45		12	VCP392ZG
		4-0	VIOLET	45		36	VCP392ZH
		4-0	UNDYED	70		36	VCP422H
		4-0	VIOLET	70		36	VCP397H
		3-0	UNDYED	45		36	VCP293H
		3-0	VIOLET	45		36	VCP393H
		3-0	UNDYED	70		36	VCP423H
		3-0	VIOLET	70		36	VCP398H
	19 mm	4-0	UNDYED	45	Slimmed	36	VCP292H
		4-0	VIOLET	45	Slimmed	36	VCP392H
	24 mm	4-0	UNDYED	70		36	VCP441H
		4-0	VIOLET	70		36	VCP451H
		3-0	UNDYED	70		36	VCP442H
		3-0	VIOLET	70		36	VCP452H
		2-0	UNDYED	70		36	VCP443H
		2-0	VIOLET	70		36	VCP453H
	30 mm	3-0	VIOLET	70		36	VCP585H
		2-0	UNDYED	70		36	VCP589H
		2-0	VIOLET	70		36	VCP586H
		0	VIOLET	70		36	VCP587H

3/8 Circle Conventional Cutting PRIME* Needles

Needle		Gauge	Suture Color	Length (cm)	Other information	Number per box	Code
	16 mm	5-0	UNDYED	45		36	VCP9505H
		4-0	UNDYED	45		36	VCP9506H
	26 mm	4-0	UNDYED	70		36	VCP9580H
		3-0	UNDYED	70		36	VCP9581H
		2-0	UNDYED	70		36	VCP9582H

Straight Cutting Needles

Needle		Gauge	Suture Color	Length (cm)	Other information	Number per box	Code
60 mm		3-0	UNDYED	70		36	VCP663H
							

VICRYL* Plus (Polyglactin 910) Antibacterial Multifilament

Ligatures

	Gauge	Suture Color	Length (cm)	Other information	Number per box	Code
SUTUPAK*	4-0	VIOLET	2X70		24	VCPV623T
	3-0	VIOLET	2x70		24	VCP624E
	2-0	VIOLET	2x70		24	VCP625E
	0	VIOLET	2x70		24	VCP626E
	1	VIOLET	2x70		36	VCP627H
	2	VIOLET	2x70		36	VCP628H
SUTUPAK*	4-0	VIOLET	3x45		36	VCP633H
	4-0	UNDYED	3x45		36	VCPV643H
	3-0	VIOLET	3x45		36	VCP634H
	2-0	VIOLET	3x45		36	VCP635H
	0	VIOLET	3x45		24	VCP636E
	1	VIOLET	3x45		24	VCP637E
	2	VIOLET	3x45		36	VCP638H
SUTUPAK*	4-0	VIOLET	5x70		24	VCP1214E
	3-0	VIOLET	5x70		24	VCP1215E
	2-0	VIOLET	5x70		24	VCP1216E
	0	VIOLET	5x70		24	VCP1217E
	1	VIOLET	5x70		36	VCP1218H
	2	VIOLET	5x70		36	VCP1219H
SUTUPAK*	4-0	VIOLET	6x45		36	VCP1224H
	3-0	VIOLET	6x45		36	VCP1225H
	2-0	VIOLET	6x45		36	VCP1226H
	0	VIOLET	6x45		24	VCP1227E
	1	VIOLET	6x45		24	VCP1228E
	2	VIOLET	6x45		36	VCP1229H

PDS* II

(Polydioxanone) Suture



PDS* II

(Polydioxanone) Monofilament

SUTURE

Description: **Monofilament** For smooth passage through tissue.
Synthetic For minimal tissue reaction.
Absorbable By hydrolysis. Essentially complete in 182-238 days.

Tensile strength: **Post implantation** **Approximate % original strength remaining**

14 days 80% (3-0 and larger)
60% (4-0 and smaller)

28 days 70% (3-0 and larger)
40% (4-0 and smaller)

42 days 60% (3-0 and larger)
35% (4-0 and smaller)

Color: Violet or undyed.

Range: 7-0 to 2 (USP). Supplied as needed sutures and ligatures.

Indications: PDS* II sutures are intended for use in general soft tissue approximation, including use in pediatric cardiovascular tissue, in microsurgery and in ophthalmic surgery. PDS* II sutures are particularly useful where the combination of an absorbable suture and extended wound support is desirable. Typical areas of use include:













- Abdominal wall closure
- Intestinal anastomoses
- Ligament and tendon repair

Full details in the Instruction for Use included in every package.

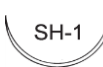



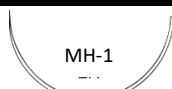





PDS* II (Polydioxanone) Monofilament

1/2 Circle Taper Point Needles

Needle	Gauge	Suture Color	Length (cm)	Other information	Number per box	Code	
TF-6 TF-6 	6,5 mm	7-0	VIOLET	45		24	PQQ2941E
TF-1 TF-1 	10 mm	6-0	VIOLET	70		24	PUU2971E
RB-2 RB-2 	13 mm	5-0	VIOLET	70		36	Z867H
TF 	13 mm	6-0	VIOLET	70		36	Z926H
		5-0	VIOLET	70		36	Z925H
		4-0	VIOLET	70		36	Z924H
TF TF 	13 mm	5-0	VIOLET	70		36	Z935H
RB-1 	17 mm	5-0	VIOLET	70		36	Z303H
		4-0	VIOLET	70		36	Z304H
		3-0	VIOLET	70		36	Z305H
RB-1 RB-1 	17 mm	5-0	VIOLET	90		36	W9108H
		4-0	VIOLET	70		36	Z864H
		4-0	VIOLET	90		36	W9109H
SH-1 	22 mm	4-0	VIOLET	70		36	Z310H
		4-0	VIOLET	70		36	Z3100H
		4-0	VIOLET	4x70 C/R	VISI-BLACK*	12	X1154G
		3-0	VIOLET	70		36	Z311H
		3-0	VIOLET	70	VISI-BLACK*	36	Z3110H
SH-1 SH-1 	22 mm	4-0	VIOLET	70		36	Z1310H
		4-0	VIOLET	75	VISI-BLACK*	36	Z1312H
		3-0	VIOLET	70		36	Z1311H
		3-0	VIOLET	90		36	PEE2994H
SH 	26 mm	4-0	VIOLET	70		36	Z315H
		3-0	VIOLET	70		36	Z316H
		3-0	VIOLET	70	VISI-BLACK*	36	Z3160H
		2-0	VIOLET	70		36	Z317H
		2-0	VIOLET	70	VISI-BLACK*	36	Z3170H
		2-0	VIOLET	120		36	Z120H
SH SH 	26 mm	4-0	VIOLET	90	VISI-BLACK*	24	X976E
		3-0	VIOLET	70		36	Z1316H
		3-0	VIOLET	90	VISI-BLACK*	36	Z5270H
		2-0	VIOLET	90		36	Z528H
MH-1 	31 mm	3-0	VIOLET	70		36	W9132H
		2-0	VIOLET	150	Loop	36	PV2924SH
MH 	36 mm	3-0	VIOLET	70		36	Z322H
		2-0	VIOLET	70		36	Z323H

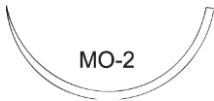

PDS* II (Polydioxanone) Monofilament

1/2 Circle Taper Point Needles (Heavier Wire Diameter)





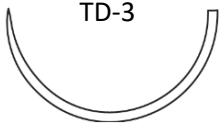

Needle		Gauge	Suture Color	Length (cm)	Other information	Number per box	Code
 UCL	13 mm	3-0	VIOLET	70		36	Z113H
		2-0	VIOLET	70		36	Z114H
 UCLX	16 mm	3-0	VIOLET	70		36	Z13H
		2-0	VIOLET	70		36	Z14H
		0	VIOLET	70		36	Z15H
 CT-3	22 mm	2-0	VIOLET	70		36	Z328H
		0	VIOLET	70		36	Z329H
 CT-2	26 mm	2-0	VIOLET	70		36	Z333H
		0	VIOLET	70		36	Z334H
		1	VIOLET	70		36	Z335H
 CT-1	36 mm	3-0	VIOLET	70		36	Z338H
		2-0	VIOLET	70		36	Z339H
		2-0	VIOLET	150		12	Z1927G
		0	VIOLET	70		36	Z340H
		1	VIOLET	70		36	Z341H
 MO-2	40 mm	0	VIOLET	150	Loop	24	W9236T
		1	VIOLET	150	Loop	24	W9237T
 CT	40 mm	2-0	VIOLET	90		24	Z357E
		0	VIOLET	90		24	Z358E
		1	VIOLET	90		24	Z359E
 CTX	48 mm	0	VIOLET	90		24	Z370E
		0	VIOLET	150		12	Z1926G
		0	VIOLET	150	Loop	12	PN2925SG
		0	VIOLET	150	Loop	24	W9261T
		1	VIOLET	90		24	Z371E
		1	VIOLET	150	Loop	24	W9262T
		1	VIOLET	240	Loop	12	XN9263G
 TP-1	65 mm	0	VIOLET	150	Loop	12	PS2925SG
		1	VIOLET	150		12	PS2926G
 XLH	70 mm	0	VIOLET	70		12	Z582G

PDS* II (Polydioxanone) Monofilament

1/2 Circle ETHIGUARD* Blunt Point Needles

Needle		Gauge	Suture Color	Length (cm)	Other information	Number per box	Code
TD-3 	45 mm	1	VIOLET	90		24	W9965T
CTXD 	48 mm	0	VIOLET	150	Loop	24	W9966T
		1	VIOLET	150	Loop	24	W9967T

3/8 Circle Taper Point Needles

Needle		Gauge	Suture Color	Length (cm)	Other information	Number per box	Code
BV175-8 	9,3 mm	7-0	VIOLET	70	VISI-BLACK*	24	Z161E
BV-1 BV-1 	9,3 mm	7-0	VIOLET	70		24	Z1701E
	9,3 mm	6-0	VIOLET	70		36	Z1702H
BV BV 	11 mm	6-0	VIOLET	70		36	Z1002H
C-1 	13 mm	6-0	VIOLET	70		36	Z1012H
	13 mm	5-0	VIOLET	70		36	Z1013H
C-1 C-1 	13 mm	7-0	VIOLET	45		24	W9095T
		6-0	VIOLET	70		36	Z1721H
		5-0	VIOLET	70		36	Z1722H
BB BB 	17 mm	5-0	VIOLET	70		36	FZ1741H

PDS* II (Polydioxanone) Monofilament

5/8 Circle Taper Point Needles

Needle	Gauge	Suture Color	Length (cm)	Other information	Number per box	Code
 UR-6 26 mm	2-0	VIOLET	70		36	VC2973H
 UR-6 26 mm	3-0	VIOLET	70		24	Z605E
 MF-110 HVY 110 mm	0	VIOLET	150	Loop	12	W9168

5/8 Circle ETHIGUARD* Blunt Point Needles

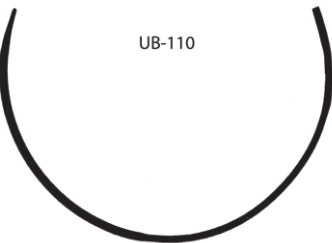

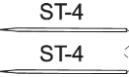
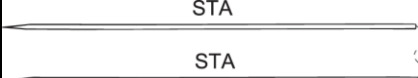

Needle	Gauge	Suture Color	Length (cm)	Other information	Number per box	Code
 UB-110 110 mm	0	VIOLET	240	Loop	12	W9968

Straight Taper Point Needles

Needle	Gauge	Suture Color	Length (cm)	Other information	Number per box	Code
 ST-4 19 mm	5-0	VIOLET	35		36	BA2932H
 ST-4 19 mm	4-0	VIOLET	35		24	Z620E
 STA 65 mm	0	VIOLET	70		24	Z630E

PDS* II (Polydioxanone) Monofilament



1/2 Circle TAPERCUT* Needles

Needle		Gauge	Suture Color	Length (cm)	Other information	Number per box	Code
 V-5	17 mm	5-0	VIOLET	70		36	Z995H
		4-0	VIOLET	70		36	Z994H
		3-0	VIOLET	70		36	Z276H
		2-0	VIOLET	70		36	Z274H
 V-6	22 mm	4-0	VIOLET	70		36	Z275H
		3-0	VIOLET	70		36	Z277H
 V-7	26 mm	4-0	VIOLET	70		36	Z997H
		3-0	VIOLET	70		36	Z998H
		2-0	VIOLET	70		36	Z999H
 V-34	36 mm	2-0	VIOLET	70		36	W9380H
		0	VIOLET	90		36	W9381H
		1	VIOLET	90		24	W9352T
 V-37	40 mm	0	VIOLET	150	Loop	24	Z1932E

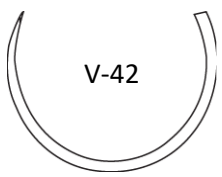
5/8 Circle TAPERCUT* Needles

Needle		Gauge	Suture Color	Length (cm)	Other information	Number per box	Code
 V-42	63 mm	1	VIOLET	150	Loop	12	OT2924SG

3/8 Circle CC-Needles



Needle		Gauge	Suture Color	Length (cm)	Other information	Number per box	Code
 CC	9,3 mm	7-0	VIOLET	70		24	Z1711E
		6-0	VIOLET	70		36	Z1712H
 CC-1	13 mm	6-0	VIOLET	70		36	Z1032H
		5-0	VIOLET	70		24	Z1033E

3/8 Circle TAPERCUT* Needles

Needle		Gauge	Suture Color	Length (cm)	Other information	Number per box	Code
 V-18	13 mm	6-0	VIOLET	70		36	Z991H
		5-0	VIOLET	70		36	Z990H

PDS* II (Polydioxanone) Monofilament







Fish hook Needles

Needle		Gauge	Suture Color	Length (cm)	Other information	Number per box	Code
 V-38	31 mm	1	VIOLET	70	Tapercut*	24	W9334T
		0	VIOLET	70	Tapercut*	24	W9333T
 ASH-35	36 mm	2-0	VIOLET	70		24	W9219T

Straight TAPERCUT* Needles







Needle		Gauge	Suture Color	Length (cm)	Other information	Number per box	Code
 V-47	38 mm	4-0	VIOLET	35		24	Z425E

1/2 Circle Reverse Cutting Needles (Heavier Wire Diameter)



Needle		Gauge	Suture Color	Length (cm)	Other information	Number per box	Code
 OS-4	22 mm	1	VIOLET	70	Heavy Needle	24	W9286T
 X-1	22 mm	3-0	UNDYED	70		24	Z458E
 CP-2	26 mm	2-0	VIOLET	70		36	Z969H
		0	VIOLET	70		36	Z983H
		1	VIOLET	70		36	Z984H
 CP-1	36 mm	2-0	VIOLET	70		36	Z466H
		0	VIOLET	70		36	Z467H
		1	VIOLET	70		36	Z468H
 CP	40 mm	0	VIOLET	90		24	Z485E
		1	VIOLET	90		24	W9324T
		2	VIOLET	70		24	MH2976E
 CPX		1	VIOLET	90		24	Z1058E

PDS* II (Polydioxanone) Monofilament

3/8 Circle Reverse Cutting PRIME* Needles



Needle		Gauge	Suture Color	Length (cm)	Other information	Number per box	Code
 P-1	11 mm	6-0	VIOLET	45		36	Z487H
		6-0	UNDYED	45		24	Z489E
		6-0	UNDYED	45	MULTIPASS*	36	MPZ489H
		5-0	UNDYED	45		24	Z490E
 P-3	13 mm	5-0	VIOLET	45		36	Z463H
		5-0	UNDYED	45		24	Z493E
		5-0	UNDYED	45	MULTIPASS*	36	MPZ493H
		4-0	VIOLET	45		36	Z464H
		4-0	UNDYED	45		24	Z494E
		4-0	UNDYED	45	MULTIPASS*	36	MPZ494H
 PS-3	16 mm	5-0	UNDYED	45	MULTIPASS*	36	MPZ500H
		5-0	UNDYED	45		24	W9872T
		4-0	UNDYED	45	MULTIPASS*	36	MPZ501H
		4-0	UNDYED	45		24	W9873T
 PS-2	19 mm	4-0	UNDYED	45		24	W9874T
		4-0	UNDYED	45	MULTIPASS*	36	MPZ496H
		3-0	UNDYED	45	MULTIPASS*	36	MPZ497H
		3-0	UNDYED	45		24	Z497E
 PS-2 S	19 mm	4-0	UNDYED	45	Slimmed	24	Z496E
		4-0	VIOLET	45	Slimmed	36	Z513H
 PS-1	24 mm	4-0	UNDYED	45	MULTIPASS*	36	MPZ682H
		3-0	UNDYED	45	MULTIPASS*	36	MPZ683H
		3-0	UNDYED	45		24	Z683E
		2-0	UNDYED	45		24	Z684E
 PS	26 mm	2-0	UNDYED	45	MULTIPASS*	36	MPZ9626H
		2-0	UNDYED	70		24	W9626T

3/8 Circle Reverse Cutting Needles

Needle		Gauge	Suture Color	Length (cm)	Other information	Number per box	Code
 FS-2	19 mm	5-0	UNDYED	70		24	Z421E
		4-0	VIOLET	30	Loop	36	Z282H
		3-0	UNDYED	45		24	Z293E
		3-0	UNDYED	70		24	Z423E
 FS-2S	19 mm	4-0	UNDYED	45	Slimmed	24	Z292E
		4-0	UNDYED	70	Slimmed	24	Z422E
 FS-1	24 mm	4-0	UNDYED	70		24	Z441E
		3-0	VIOLET	70		36	Z452H
		3-0	UNDYED	70		24	Z442E
		2-0	UNDYED	70		24	Z443E

PDS* II (Polydioxanone) Monofilament

3/8 Circle Conventional Cutting PRIME* Needles

Needle		Gauge	Suture Color	Length (cm)	Other information	Number per box	Code
PC-1 	13 mm	6-0	UNDYED	45		24	W9861T
PCLX 	36 mm	2-0	UNDYED	70		24	W9631T

1/2 Circle Reverse Cutting PRIME* Needles

Needle		Gauge	Suture Color	Length (cm)	Other information	Number per box	Code
P-2 	8 mm	5-0	VIOLET	45		36	JG2942H

Ligatures

	Gauge	Suture Color	Length (cm)	Other information	Number per box	Code
SUTUPAK*	2-0	VIOLET	2x70		36	Z625H
	0	VIOLET	2x70		24	Z626E
	1	VIOLET	2x70		24	Z627E

PDS* Plus

(Polydioxanone) Antibacterial Monofilament

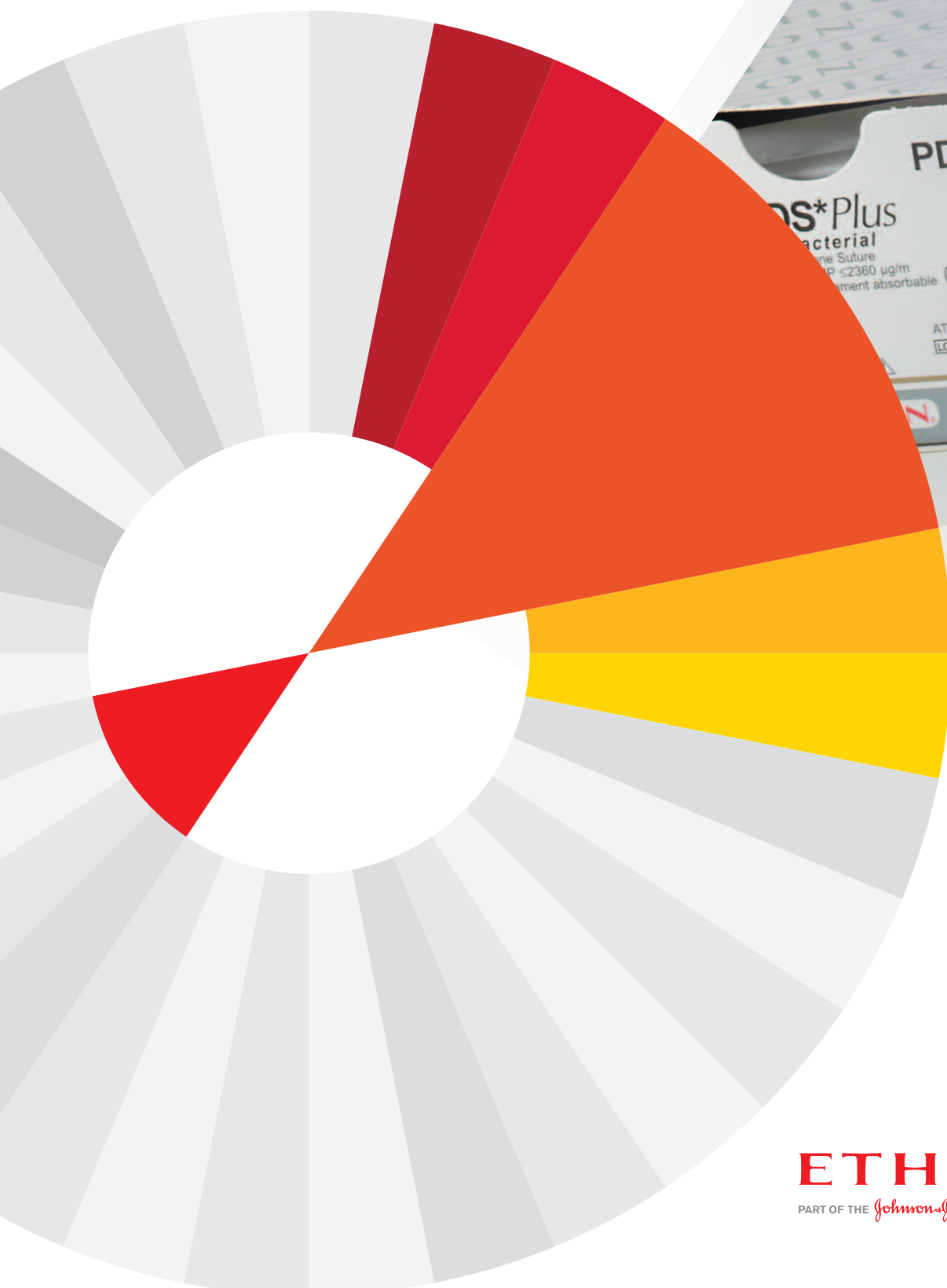

ETHICON

PART OF THE *Johnson & Johnson* FAMILY OF COMPANIES

PDS* PLUS

(Polydioxanone) Antibacterial Monofilament

SUTURE

Description: **Monofilament** For smooth passage through tissue.
Synthetic For minimal tissue reaction.
Absorbable By hydrolysis. Essentially complete in 182-238 days.

Tensile strength: **Post implantation** **Approximate % of original strength remaining**

14 days	80% (3-0 and larger)
	60% (4-0 and smaller)
28 days	70% (3-0 and larger)
	40% (4-0 and smaller)
42 days	60% (3-0 and larger)
	35% (4-0 and smaller)

Color: Violet or undyed

Range: 6-0 to 1 (USP). Supplied as needled sutures and ligatures.

Indications: PDS* Plus Antibacterial Sutures are intended for use in general soft tissue approximation, including in paediatric cardiovascular tissue, and in ophthalmic surgery (other than contact with cornea and sclera). PDS* Plus Antibacterial Sutures are particularly useful where the combination of absorbable suture and extended wound support is desirable. Typical areas of use include:

- Abdominal wall closure
- Intestinal anastomoses
- Ligament and tendon repair

Protection against bacterial colonization







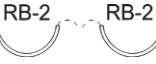

In vitro studies demonstrate, that PDS* Plus Antibacterial Suture has a zone of inhibition that is effective against the pathogens that most frequently cause surgical site infection, including Staphylococcus aureus, methicillin resistant Staphylococcus aureus (MRSA), Staphylococcus epidermidis, methicillin resistant Staphylococcus epidermidis (MRSE), E. coli and Klebsiella pneumoniae.

Full details in the Instruction for Use included in every package.



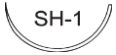

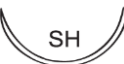



PDS* Plus (Polydioxanone) Antibacterial Monofilament

1/2 Circle Taper Point Needles

Needle	Gauge	Suture Color	Length (cm)	Other information	Number per box	Code	
	10 mm	6-0	VIOLET	70		36	PDP2971H
	13 mm	5-0	VIOLET	70		36	PDP9201H
	13 mm	6-0	VIOLET	70		36	PDP926H
		5-0	VIOLET	70		36	PDP925H
		4-0	VIOLET	70		36	PDP924H
	13 mm	5-0	VIOLET	70		36	PDP935H
	17 mm	5-0	VIOLET	70		36	PDP303H
		4-0	VIOLET	70		36	PDP304H
		3-0	VIOLET	70		36	PDP305H
	17 mm	4-0	VIOLET	70		36	PDP864H
	22 mm	4-0	VIOLET	70		36	PDP310H
		4-0	VIOLET	70	VISI-BLACK*	36	PDP3100H
		3-0	VIOLET	70		36	PDP311H
	22 mm	4-0	VIOLET	70		36	PDP1310H
		4-0	VIOLET	70	VISI-BLACK*	36	PDP1312H
		3-0	VIOLET	70		36	PDP1311H
	26 mm	4-0	VIOLET	70		36	PDP315H
		3-0	VIOLET	70		36	PDP316H
		3-0	VIOLET	70	VISI-BLACK*	36	PDP3160H
		2-0	VIOLET	70		36	PDP317H
		2-0	VIOLET	70	VISI-BLACK*	36	PDP3170H
	26 mm	4-0	VIOLET	90	VISI-BLACK*	36	PDP976H
		3-0	VIOLET	90	VISI-BLACK*	36	PDP5270H
	36 mm	3-0	VIOLET	70		36	PDP322H
		2-0	VIOLET	70		36	PDP323H

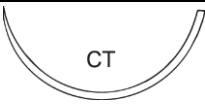
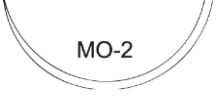

PDS* Plus (Polydioxanone) Antibacterial Monofilament

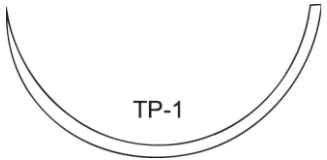
1/2 Circle Taper Point Needles (Heavier Wire Diameter)

Needle		Gauge	Suture Color	Length (cm)	Other information	Number per box	Code
 UCL	13 mm	3-0	VIOLET	70		36	PDP113H
		2-0	VIOLET	70		36	PDP114H
 UCLX	16 mm	2-0	VIOLET	70		36	PDP14H
		0	VIOLET	70		36	PDP15H
 CT-3	22 mm	2-0	VIOLET	70		36	PDP328H
		0	VIOLET	70		36	PDP329H
 CT-2	26 mm	2-0	VIOLET	70		36	PDP333H
		0	VIOLET	70		36	PDP334H
		0	VIOLET	150		24	D10180
		1	VIOLET	70		36	PDP335H
 CT-1	36 mm	3-0	VIOLET	70		36	PDP338H
		2-0	VIOLET	70		36	PDP339H
		0	VIOLET	70		36	PDP340H
		0	VIOLET	90		36	PDPL995H
		0	VIOLET	150		24	D10179
		1	VIOLET	70		36	PDP341H
 CT	40 mm	2-0	VIOLET	90		36	PDP357H
		0	VIOLET	90		36	PDP358H
		1	VIOLET	90		36	PDP9234H
 MO-2	40 mm	0	VIOLET	150	Loop	24	PDP9236T
		1	VIOLET	150	Loop	24	PDP9237T
 CTX	48 mm	0	VIOLET	150		24	PDP1926T
		0	VIOLET	150	Loop	24	PDP925ST
		0	VIOLET	150	Loop	24	PDP9261T
		0	VIOLET	90		36	PDP370H
		1	VIOLET	150	Loop	24	PDP9262T
		1	VIOLET	244	Loop	12	D10178
		1	VIOLET	90		36	PDP371H
 TP-1	65 mm	0	VIOLET	150	Loop	24	PDPS925ST
		1	VIOLET	150		24	PDPS926T

PDS* Plus (Polydioxanone) Antibacterial Monofilament

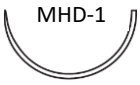

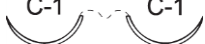

1/2 Circle ETHIGUARD* Blunt Point Needles

Needle	Gauge	Suture Color	Length (cm)	Other information	Number per box	Code	
 MHD-1	31 mm	20	VIOLET	70		36	PDP9959H
 TD-3	45 mm	1	VIOLET	90		36	PDP9965H
 CTXD	48 mm	0	VIOLET	150	Loop	24	PDP9966T
		1	VIOLET	150	Loop	24	PDP9967T

3/8 Circle Taper Point Needles

Needle	Gauge	Suture Color	Length (cm)	Other information	Number per box	Code	
 BV-1	9,3 mm	6-0	VIOLET	70		36	PDP1702H
 C-1	13 mm	5-0	VIOLET	70		36	PDP1722H

1/2 Circle TAPERCUT* Needles

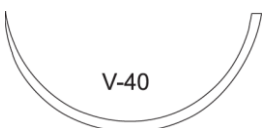



Needle	Gauge	Suture Color	Length (cm)	Other information	Number per box	Code	
 V-5	17 mm	5-0	VIOLET	70		36	PDP995H
		4-0	VIOLET	70		36	PDP994H
		3-0	VIOLET	70		36	PDP276H
		2-0	VIOLET	70		36	PDP274H
 V-6	22 mm	3-0	VIOLET	70		36	PDP277H
 V-7	26 mm	3-0	VIOLET	70		36	PDP9179H
		2-0	VIOLET	70		36	PDP9184H
 V-37	40 mm	0	VIOLET	150	Loop	24	PDP1932T
 V-40	48 mm	0	VIOLET	150	Loop	24	PDP1933T

PDS* Plus (Polydioxanone) Antibacterial Monofilament





Fish hook TAPERCUT* Needles

Needle		Gauge	Suture Color	Length (cm)	Other information	Number per box	Code
 V-38	31 mm	0	VIOLET	70		36	PDP9333H
		1	VIOLET	70		36	PDP9334H

1/2 Circle Reverse Cutting Needles (Heavier Wire Diameter)



Needle		Gauge	Suture Color	Length (cm)	Other information	Number per box	Code
 X-1	22 mm	3-0	UNDYED	70		36	PDP458H
 CP-2	26 mm	2-0	VIOLET	70		36	PDP969H
		0	VIOLET	70		36	PDP983H
		1	VIOLET	70		36	PDP984H
 CP-1	36 mm	2-0	VIOLET	70		36	PDP466H
		0	VIOLET	70		36	PDP467H
		1	VIOLET	70		36	PDP468H
 CP	40 mm	0	VIOLET	90		36	PDP485H
 CPX	48 mm	0	VIOLET	90		36	PDP1057H
		1	VIOLET	90		36	PDP9299H

3/8 Circle Reverse Cutting PRIME* Needles

Needle		Gauge	Suture Color	Length (cm)	Other information	Number per box	Code
 P-1	11 mm	6-0	UNDYED	45	MULTIPASS	36	PDP489H
		5-0	UNDYED	45	MULTIPASS	36	PDP490H
 P-3	13 mm	5-0	UNDYED	45	MULTIPASS	36	PDP493H
		5-0	VIOLET	45	MULTIPASS	36	PDP463H
		4-0	UNDYED	45	MULTIPASS	36	PDP494H
 PS-2	19 mm	3-0	UNDYED	45	MULTIPASS	36	PDP497H
 PS-2 S	19 mm	4-0	UNDYED	45	Slimmed	36	PDP496H
 PS-1	24 mm	3-0	UNDYED	45	MULTIPASS	36	PDP683H
		2-0	UNDYED	45	MULTIPASS	36	PDP684H

PDS* Plus (Polydioxanone) Antibacterial Monofilament

3/8 Circle Reverse Cutting Needles

Needle		Gauge	Suture Color	Length (cm)	Other information	Number per box	Code
 FS-2	19 mm	5-0	UNDYED	70		36	PDP421H
		4-0	UNDYED	45		36	PDP9950H
		3-0	UNDYED	70		36	PDP423H
 FS-2S	19 mm	4-0	UNDYED	70		36	PDP422H
 FS-1	24 mm	4-0	UNDYED	70		36	PDP441H
		3-0	UNDYED	70		36	PDP442H
		2-0	UNDYED	70		36	PDP443H

Straight Cutting Needles

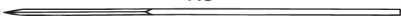
Needle		Gauge	Suture Color	Length (cm)	Other information	Number per box	Code
 KS	60 mm	3-0	UNDYED	70		36	PDP9714H

Ligatures

	Gauge	Suture Color	Length (cm)	Other information	Number per box	Code
SUTUPAK*	0	VIOLET	2X70		36	PDP626H

PROLENE*

Monofilament Polypropylene



ETHICON
PART OF THE *Johnson & Johnson* FAMILY OF COMPANIES

PROLENE*

Monofilament Polypropylene

SUTURE

Description: **Monofilament** For smooth passage through tissue.
Synthetic For minimal tissue reaction.
Non-absorbable Provides permanent tensile strength retention in tissue.

Color: Blue or clear.

Range: 10-0 to 2 (USP). Supplied as needled sutures, armed with, for example, EVERPOINT* Tungsten-Rhenium needles, VISI-BLACK* needles, MULTIPASS* needles or CC-needles. Also available with pledgets.

PROLENE* sutures are also available as HEMO-SEAL*, with suture diameter to needle diameter ratio close to 1. HEMO-SEAL* is particularly useful in reducing needle hole leakage (for example in synthetic vascular grafts).

Indications: PROLENE* sutures are intended for use in general soft tissue approximation and/or ligation, including use in cardiovascular, ophthalmic and neurosurgical procedures. Typical areas of use include:





- Cardiovascular anastomoses
- Subcuticular sutures

Full details in the Instruction for Use included in every package.





PROLENE* Monofilament Polypropylene

3/8 Circle Taper Point Needles

Needle		Gauge	Suture Color	Length (cm)	Other information	Number per box	Code
BV130-5 	6,5 mm, 150 microns	8-0	BLUE	7	VISI-BLACK*	24	EH7456E
		8-0	BLUE	45	EVERPOINT*	36	EP8730H
		8-0	BLUE	45	VISI-BLACK*	12	X916G
		8-0	BLUE	45	MULTIPASS*	24	EH7470E
		8-0	BLUE	45	MULTIPASS*	12	W2777
		8-0	BLUE	60	VISI-BLACK*	12	F1894
		8-0	BLUE	60	EVERPOINT*	36	EP8732H
		8-0	BLUE	60	MULTIPASS*	36	KHH5662H
		8-0	BLUE	75	VISI-BLACK*	24	EH7459E
		8-0	BLUE	75	MULTIPASS*	24	EH7469E
		8-0	BLUE	75	Straight pack, MULTIPASS*	12	EH7469LG
		7-0	BLUE	60	VISI-BLACK*	36	8207H
		7-0	BLUE	2x75	Straight pack, MULTIPASS*	12	KHL5673JG
BV130-5 	6,5 mm	8-0	BLUE	13	150 microns	12	W2775
BV175-6 	8 mm, 200 microns	8-0	BLUE	45	MULTIPASS*, 150 microns	36	8740H
		8-0	BLUE	60	VISI-BLACK*	36	8841H
		8-0	BLUE	60	EVERPOINT*	36	EP8741H
		8-0	BLUE	60	MULTIPASS*, 150 microns	36	8741H
		7-0	BLUE	60	VISI-BLACK*	36	8335H
		7-0	BLUE	60	MULTIPASS*	36	8735H
		7-0	BLUE	60	EVERPOINT*	36	EP8735H
		7-0	BLUE	2X60	EVERPOINT*, Straight pack	12	EPM8737
		7-0	BLUE	2x60	Straight pack, VISI-BLACK*	12	M8935
BV175-7 	8 mm, 200 microns	8-0	BLUE	2x60	Straight pack, VISI-BLACK*	12	M8967
		7-0	BLUE	60		36	8766H
		7-0	BLUE	2x60	Straight pack	12	M8766
BV175-8 	9,3 mm, 200 microns	7-0	BLUE	45	VISI-BLACK*	36	EH7225H
		7-0	BLUE	45	EVERPOINT*	36	EP8746H
		7-0	BLUE	45	MULTIPASS*	36	8701H
		7-0	BLUE	60	EVERPOINT*	36	EP8747H
		7-0	BLUE	60	MULTIPASS*	12	W8702
		7-0	BLUE	4x60	VISI-BLACK*	12	X967G
		7-0	BLUE	4X60	EVERPOINT*, Straight pack	12	EPM8745
		7-0	BLUE	4x60	Straight pack, MULTIPASS*	12	W8702S
		7-0	BLUE	75	VISI-BLACK*	36	EH7222H
		7-0	BLUE	75	EVERPOINT*	36	EP8755H
		7-0	BLUE	75	MULTIPASS*	36	EH7405H
		7-0	BLUE	2x75	Straight pack, VISI-BLACK*	12	MEH7224JG
		7-0	BLUE	4x75	Straight pack, MULTIPASS*	12	M8702G

PROLENE* Monofilament Polypropylene

3/8 Circle Taper Point Needles

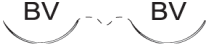
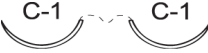
Needle		Gauge	Suture Color	Length (cm)	Other information	Number per box	Code
	9,3 mm, 200 microns	7-0	BLUE	75	MULTIPASS*	36	EH7402H
	9,3 mm, 250 microns	7-0	BLUE	60	VISI-BLACK*	12	W8304
		7-0	BLUE	60	EVERPOINT*	36	EP8702H
		7-0	BLUE	2x60	Straight pack, VISI-BLACK*, 200 microns	12	KAA5663LG
		7-0	BLUE	75	VISI-BLACK*	36	EH7238H
		6-0	BLUE	60	VISI-BLACK*	12	W8305
		6-0	BLUE	60	EVERPOINT*	36	EP8805H
		6-0	BLUE	75	VISI-BLACK*, 200 microns	36	EH7223H
		6-0	BLUE	75	VISI-BLACK*	36	EH7240H
		6-0	BLUE	75		36	EH7245H
		6-0	BLUE	75	EVERPOINT*	36	EP8709H
		6-0	BLUE	75	200 microns	36	EH7406H
		5-0	BLUE	75	EVERPOINT*, HEMO-SEAL*	36	EPH9702H
	9,3 mm	6-0	BLUE	75	200 microns	36	EH7403H
	11 mm, 250 microns	6-0	BLUE	75		36	8776H
	13 mm, 250 - 450 microns	7-0	BLUE	60	300 microns	12	W8725
		7-0	BLUE	75	300 microns	36	8708H
		7-0	BLUE	75	EVERPOINT*, 250 microns	36	EP8708H
		6-0	BLUE	45	VISI-BLACK*, 250 microns	36	X577H
		6-0	BLUE	60	VISI-BLACK*, 300 microns	12	W8307
		6-0	BLUE	60	300 mikrons	12	W8718
		6-0	BLUE	75	VISI-BLACK*, 250 microns	36	EH7228H
		6-0	BLUE	75	300 microns	36	8706H
		6-0	BLUE	75	EVERPOINT*, 250 microns	36	EP8706H
		6-0	BLUE	4x75	EVERPOINT*, Straight pack, 250 microns	12	EPM8706
		6-0	BLUE	4x75	Straight pack, VISI-BLACK*, 300 microns	12	M807C
		6-0	BLUE	90	VISI-BLACK*, 250 microns	36	EH7230H
		5-0	BLUE	45	300 microns	36	8717H
		5-0	BLUE	60	300 microns	36	KBB5661H
		5-0	BLUE	60	EVERPOINT*, HEMO-SEAL*, 250 microns	36	EPH8725H
		5-0	BLUE	70	With pledget 4x3mm, 300 microns	12	KBB5671VG
		5-0	BLUE	75	300 microns	36	EH7477H
		5-0	BLUE	75	Heavier Wire Diameter 350 microns	36	EH7255H



PROLENE* Monofilament Polypropylene

3/8 Circle Taper Point Needles

Needle	Gauge	Suture Color	Length (cm)	Other information	Number per box	Code	
 C-1 C-1	13 mm, 250 - 450 microns	5-0	BLUE	75	VISI-BLACK*, Heavier Wire Diameter 350 microns	36	EH7257H
		5-0	BLUE	75	EVERPOINT*, HEMO- SEAL*, 250 microns	36	EPH7477H
		5-0	BLUE	75	VISI-BLACK*, 300 microns	36	EH7229H
		5-0	BLUE	2x75	Straight pack, VISI- BLACK*, 300 microns	12	MEH7233JG
		5-0	BLUE	90	VISI-BLACK*, 300 microns	36	EH7231H
		5-0	BLUE	90	300 microns	36	8720H
		5-0	BLUE	2x90	Straight pack	12	KBL5691JG
		5-0	BLUE	90	EVERPOINT*, HEMO- SEAL*, 250 microns	36	EPH8720H
		4-0	BLUE	75	450 microns	36	EH7478H









PROLENE* Monofilament Polypropylene

3/8 Circle Taper Point Needles

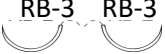
Needle	Gauge	Suture Color	Length (cm)	Other information	Number per box	Code	
 C-1	13 mm, 250 - 450 microns	6-0	BLUE	75	VISI-BLACK*, 250 microns	36	EH7226H
		5-0	BLUE	75	VISI-BLACK*, 300 microns	36	EH7227H
		6-0	BLUE	75	EVERPOINT*, 250 microns	36	EP8889H
		6-0	BLUE	75	250 microns	36	8889H
		5-0	BLUE	75	300 microns	36	8890H
		5-0	BLUE	75	350 microns	36	EH7254H
		5-0	BLUE	75	EVERPOINT*, HEMO- SEAL*, 250 microns	36	EPH8890H
 BB BB	17 mm	5-0	BLUE	90		36	8580H
		4-0	BLUE	90		36	8581H
 BB	17 mm	5-0	BLUE	75		36	8880H
		4-0	BLUE	75		36	8881H

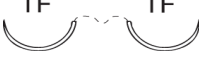



PROLENE* Monofilament Polypropylene

1/2 Circle Taper Point Needles

Needle		Gauge	Suture Color	Length (cm)	Other information	Number per box	Code
	6,5 mm	7-0	BLUE	45		24	EH7813E
		7-0	BLUE	75		36	PQQ5671H
		6-0	BLUE	45		24	EH7814E
		6-0	BLUE	60		24	PQQ5660E
	10 mm	6-0	BLUE	75		36	EH7835H
		5-0	BLUE	60	HEMO-SEAL*	36	PUU5662SH
	11 mm	7-0	BLUE	60		36	8206H
	13 mm	6-0	BLUE	45	300 microns	36	8714H
		6-0	BLUE	75	EVERPOINT*, 250 microns	36	EP8711H
		6-0	BLUE	75	250 microns	36	8711H
		5-0	BLUE	75	300 microns	36	8710H
		5-0	BLUE	4x75	Straight pack, 350 microns	12	M8710G
		5-0	BLUE	75	EVERPOINT*, HEMO-SEAL*	36	EPH8710H
	13 mm	6-0	BLUE	75	350 microns	36	EH7400H
		5-0	BLUE	60	350 microns	36	8205H
		5-0	BLUE	75	350 microns	36	EH7401H
		5-0	BLUE	75	2x2 mm firm pledget, 350 microns	36	EH7412H
		4-0	BLUE	90	450 microns	36	EH7411H
	17 mm	5-0	BLUE	75	HEMO-SEAL*	36	HS6856H
		5-0	BLUE	90	VISI-BLACK*	36	VB50H
		5-0	BLUE	90		36	8556H
		5-0	BLUE	90	HEMO-SEAL*	36	HS8556H
		4-0	BLUE	90	VISI-BLACK*	36	8357H
		4-0	BLUE	90		36	8557H
		4-0	BLUE	90	HEMO-SEAL*	36	HS6857H
		3-0	BLUE	90		36	8558H
	17 mm	5-0	BLUE	75		36	8870H
		4-0	BLUE	75		36	8871H
		3-0	BLUE	75		36	8872H
	20 mm	4-0	BLUE	90	HEMO-SEAL*	36	HS6861H



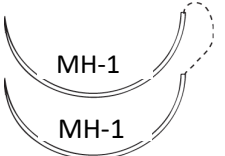
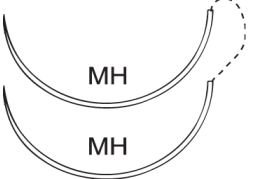

PROLENE* Monofilament Polypropylene

1/2 Circle Taper Point Needles (Heavier Wire Diameter)

Needle		Gauge	Suture Color	Length (cm)	Other information	Number per box	Code
	22 mm	4-0	BLUE	90		36	EH7585H
		4-0	BLUE	90	With pledget 5x8mm soft	36	PEE5693SH
		3-0	BLUE	90		36	EH7586H
	22 mm	4-0	BLUE	75		36	EH7581H
		3-0	BLUE	75		36	EH7582H
	26 mm	4-0	BLUE	90	VISI-BLACK*	36	EH8087H
		4-0	BLUE	90	HEMO-SEAL*	36	HS6855H
		4-0	BLUE	90	Pledget 6x3mm firm, Straight pack	12	EH7190LG
		4-0	BLUE	90		36	8521H
		4-0	BLUE	90	Pledget 5x8mm soft, VISI-BLACK*	36	EH8062H
		4-0	BLUE	120		36	EH7583H
		3-0	BLUE	90	VISI-BLACK*	36	EH8086H
		3-0	BLUE	90		36	8522H
		3-0	BLUE	90	HEMO-SEAL*	36	HS6822H
		3-0	BLUE	120		36	EH7584H
		2-0	BLUE	90		36	8523H
	26 mm	4-0	BLUE	75		36	8831H
		3-0	BLUE	75		36	8832H
		2-0	BLUE	75		36	8833H
		0	BLUE	75		36	8834H
	31 mm	3-0	BLUE	120	VISI-BLACK*	36	X1295H
		3-0	BLUE	90	VISI-BLACK*	36	EH8091H
		2-0	BLUE	90		12	W8526
	36 mm	3-0	BLUE	90		36	EH7499H
		2-0	BLUE	90		36	PGG5694H
		2-0	BLUE	122		36	8853H

PROLENE* Monofilament Polypropylene

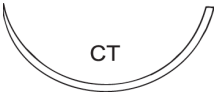
1/2 Circle Taper Point Needles (Heavier Wire Diameter)

Needle	Gauge	Suture Color	Length (cm)	Other information	Number per box	Code
 CT-2	26 mm	2-0	75		36	8411H
		0	75		36	8412H
		1	90		36	PK5696H
 CT-1	36 mm	3-0	75		36	8422H
		2-0	75		36	8423H
		0	75		36	8424H
		1	75		36	8425H
 CT	40 mm	0	75		36	8434H
		1	100		12	W742
 CTX	48 mm	0	90		36	PN5695H
		1	150	Loop	12	8527G

Compound Curve Taper Point Needles

Needle	Gauge	Suture Color	Length (cm)	Other information	Number per box	Code
 ABV 1	9,3 mm	7-0	75		36	EH8000H
 AC-1	13 mm	6-0	75		36	EH8010H
 AC-1		5-0	75		36	EH8014H

5/8 Circle Taper Point Needles





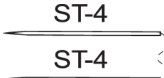
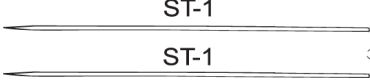
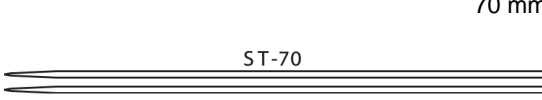

Needle	Gauge	Suture Color	Length (cm)	Other information	Number per box	Code
 UR-6	26 mm	2-0	75		36	VC5673H

Straight Taper Point Needles

Needle	Gauge	Suture Color	Length (cm)	Other information	Number per box	Code
 ST-4	19 mm	4-0	35		36	EH7508H
 ST-1	45 mm	3-0	35		36	EH7921H
 ST-70	70 mm	2-0	75		12	W8400







PROLENE* Monofilament Polypropylene

3/8 Circle CC-Needles





Needle		Gauge	Suture Color	Length (cm)	Other information	Number per box	Code
CC175-6 	8 mm, 200 microns	8-0	BLUE	60	VISI-BLACK*	12	W8101
CC175-8 	9,3 mm, 200 microns	8-0	BLUE	60		24	EH7972E
		8-0	BLUE	60	MULTIPASS*	12	W8703
		8-0	BLUE	60	EVERPOINT*	36	EP7972H
		7-0	BLUE	45		36	8705H
		7-0	BLUE	75	EVERPOINT*	36	EP8812SLH
		7-0	BLUE	75	MULTIPASS*	36	8704H
		6-0	BLUE	60	MULTIPASS*	12	W8807
CC175-8 	9,3 mm	7-0	BLUE	75		36	EH7970H
CC CC 	9,3 mm, 250 microns	7-0	BLUE	75	VISI-BLACK*	36	EH7237H
		7-0	BLUE	75		36	EH7236H
		7-0	BLUE	75	EVERPOINT*, 275 microns	36	EP8812H
		6-0	BLUE	75	VISI-BLACK*	36	EH7234H
		6-0	BLUE	75	EVERPOINT*, 275 microns	36	EP8811H
		6-0	BLUE	75		36	EH7235H
		6-0	BLUE	60	EVERPOINT*, 275 microns	36	EP8807H
		5-0	BLUE	60	HEMOSEAL*	12	W8662
CC-11 	11 mm	6-0	BLUE	60		12	W8802
CC-1 CC-1 	13 mm	6-0	BLUE	45		36	8719H
		6-0	BLUE	75	MULTIPASS*	36	8707H
		6-0	BLUE	2x75	MULTIPASS*, Straight pack	12	X535G
		5-0	BLUE	75		36	EH7977H
		5-0	BLUE	75		36	EH7251H
		5-0	BLUE	90		36	8721H
CC-1 	13 mm	6-0	BLUE	75		36	EH7975H
		5-0	BLUE	75		36	EH7976H

PROLENE* Monofilament Polypropylene

3/8 Circle TAPERCUT* Needle



Needle	Gauge	Suture Color	Length (cm)	Other information	Number per box	Code	
 MV-14	5,5 mm	8-0	BLUE	60		24	EH7828E
 V-18	13 mm	6-0	BLUE	75	250 microns	36	EH7474H
		5-0	BLUE	75	300 microns	36	EH7475H
 V-18	13 mm	6-0	BLUE	75	250 microns	36	EH7471H
		5-0	BLUE	75	300 microns	36	EH7472H
 V-18 X	13 mm	5-0	BLUE	75	Heavier Wire Diameter, 350 microns	36	EH7253H
 V-4	17 mm	5-0	BLUE	75		36	F2829
		4-0	BLUE	75		36	F2828
		4-0	BLUE	90		36	8925H
 V-4	17 mm	5-0	BLUE	75		36	8941H
		4-0	BLUE	75		36	8942H
		3-0	BLUE	75		36	8943H
 V-26	26 mm	3-0	BLUE	90		36	EH7788H

1/2 Circle CC-Needles







Needle	Gauge	Suture Color	Length (cm)	Other information	Number per box	Code	
 CC-6	11 mm	7-0	BLUE	60	VISI-BLACK*	12	X1004G
 CC-4	13 mm	6-0	BLUE	60	MULTIPASS*	12	W8815
		6-0	BLUE	75	VISI-BLACK*	36	EH7242H
		5-0	BLUE	60	HEMO-SEAL*	12	W8664
		5-0	BLUE	75	VISI-BLACK*	36	EH7241H
		5-0	BLUE	2x75	VISI-BLACK*, Straight pack	12	MEH7241JG
		5-0	BLUE	75		12	W8816
		4-0	BLUE	75	HEMO-SEAL*	12	W8665
 CC-16	16 mm	3-0	BLUE	90	HEMO-SEAL*	12	W8667
 CC-25	26 mm	4-0	BLUE	90		12	W8845
 CC-30	31 mm	3-0	BLUE	90		12	W8849

PROLENE* Monofilament Polypropylene

Compound Curve CC-Needles

Needle	Gauge	Suture Color	Length (cm)	Other information	Number per box	Code
	9,3 mm	7-0	60	VISI-BLACK*	36	EH8020H
		7-0	75	VISI-BLACK*	24	EH8021E
		6-0	75	DOUBLE ARMED ACC + ACC-1	36	EH8035H
		6-0	75	VISI-BLACK*	36	EH8025H
	13 mm	6-0	75	VISI-BLACK*	36	EH8030H
		6-0	90	VISI-BLACK*	36	EH8031H
		6-0	2x75	VISI-BLACK*, Straight pack	12	MEH8034JG
		5-0	75	VISI-BLACK*	36	EH8036H
		5-0	90	VISI-BLACK*	36	EH8037H
	13 mm	6-0	75	VISI-BLACK*	36	EH8032H

1/2 Circle TAPERCUT* Needles







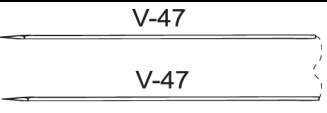

Needle	Gauge	Suture Color	Length (cm)	Other information	Number per box	Code
	17 mm	5-0	90		36	8934H
		4-0	90		36	8935H
		4-0	90	Straight pack, Pledgets	12	8954G
		3-0	90		36	8936H
		2-0	90		36	8937H
	17 mm	5-0	75		36	8951H
		4-0	75		36	8952H
		3-0	75		36	8953H
	22 mm	4-0	90		36	EH7774H
		3-0	90		36	EH7775H
	22 mm	2-0	75		36	EH7772H
	26 mm	4-0	90		36	8975H
		3-0	90		36	8976H
		3-0	90	Pledgets	36	OBB5694SH
		3-0	120		36	EH7778H
		2-0	90		36	8977H
		2-0	4x90	Straight pack, Pledgets	12	OBL5595LG
		2-0	4x90	Straight pack	12	OBL5695LG
		2-0	120		36	EH7779H
	26 mm	4-0	75		36	8962H
		3-0	75		36	8963H
		2-0	75		36	8964H
	36 mm	0	75		36	8444H

PROLENE* Monofilament Polypropylene

Straight TAPERCUT* Needles





Needle	Gauge	Suture Color	Length (cm)	Other information	Number per box	Code
 V-47	38 mm	4-0	BLUE	35	36	8592H

3/8 Circle Reverse Cutting PRIME* Needles

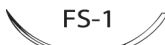
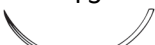

Needle	Gauge	Suture Color	Length (cm)	Other information	Number per box	Code	
 P-6	8 mm	7-0	BLUE	45	36	8648H	
		6-0	BLUE	45	24	W8870T	
 P-1	11 mm	7-0	BLUE	75	MULTIPASS*	MPP2854H	
		6-0	BLUE	45	36	8697H	
		6-0	BLUE	45	MULTIPASS*	36	MPP8697H
 P-3		6-0	BLUE	45	MULTIPASS*	36	8695H
		5-0	BLUE	45	MULTIPASS*	36	8698H
		5-0	UNDYED	75	MULTIPASS*	36	MPP2858H
		4-0	BLUE	45	MULTIPASS*	36	8699H
		4-0	UNDYED	45		36	JA5742H
		4-0	UNDYED	45	MULTIPASS*	36	MPP8604H
 PS-3	16 mm	6-0	BLUE	75	MULTIPASS*	36	MPP2832H
		5-0	BLUE	45	36	8681H	
		5-0	BLUE	45	MULTIPASS*	36	MPP8681H
		4-0	BLUE	45	36	EH7764H	
		4-0	BLUE	45	MULTIPASS*	36	EH7764H
 PS-2	19 mm	5-0	BLUE	45	MULTIPASS*	36	8686H
		4-0	BLUE	45	24	W8015T	
		4-0	BLUE	45	MULTIPASS*	36	MPP8682H
		4-0	BLUE	75	MULTIPASS*	36	EH7167H
		4-0	UNDYED	75	MULTIPASS*	36	MPP2861H
		3-0	BLUE	60	MULTIPASS*	36	EH7691H
		3-0	UNDYED	75	MULTIPASS*	36	MPP2862H
 PS-2 S	19 mm	4-0	BLUE	45	Slimmed	36	8682H
 PS-1	24 mm	4-0	BLUE	45		36	EH7758H
		4-0	BLUE	75	MULTIPASS*	36	MPP7695H
		3-0	BLUE	45	MULTIPASS*	12	8663G
		3-0	BLUE	60		12	EH7666G
		3-0	BLUE	75		36	EH7568H
 PS	26 mm	2-0	BLUE	45	MULTIPASS*	36	MPP8026H
 PSL	30 mm	2-0	BLUE	75		36	EH7121H

PROLENE* Monofilament Polypropylene

3/8 Circle Reverse Cutting Needles

Needle	Gauge	Suture Color	Length (cm)	Other information	Number per box	Code	
 C-2	13 mm	6-0	BLUE	45	250 microns	36	FD5640H
 FS-3	16 mm	6-0	BLUE	45	450 microns	36	8660H
		5-0	BLUE	45		36	8614H
 FS-2	19 mm	5-0	BLUE	45		36	8661H
		4-0	BLUE	45		36	EH7151H
		4-0	BLUE	75		36	EH7150H
		3-0	BLUE	45		36	8665H
		3-0	BLUE	75		36	EH7693H
 FS-1	24 mm	4-0	BLUE	45		36	8629H
		3-0	BLUE	45		36	8684H
		3-0	BLUE	75		36	EH7694H
 FS	26 mm	2-0	BLUE	45		36	8685H
 FSL	30 mm	3-0	BLUE	75		36	8675H
		2-0	BLUE	75		36	EH7697H
		0	BLUE	45		36	EH7920H
 FSLX	36 mm	3-0	BLUE	75		36	8649H
		2-0	BLUE	75		36	8689H
		0	BLUE	75		36	EH7561H

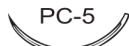
3/8 Circle Conventional Cutting PRIME* Needles



Needle	Gauge	Suture Color	Length (cm)	Other information	Number per box	Code	
 PC-3	16 mm	6-0	BLUE	45		24	W8873T
		6-0	BLUE	45	MULTIPASS*	36	8636H
		5-0	BLUE	45	MULTIPASS*	36	8635H
		4-0	BLUE	45		12	W525
		4-0	BLUE	45		24	W8007T
		4-0	BLUE	45	MULTIPASS*	36	MPP8875H
 PC-5	19 mm	5-0	BLUE	45	MULTIPASS*	36	8630G
		4-0	BLUE	45		24	W8877T
		4-0	BLUE	45	MULTIPASS*	36	MPP8877H
 PC-25	26 mm	5-0	BLUE	45		24	W8881T
		4-0	BLUE	45		24	W8879T
		3-0	BLUE	45		12	W538

1/2 Circle Reverse Cutting PRIME* Needles



Needle	Gauge	Suture Color	Length (cm)	Other information	Number per box	Code	
 PS-4	16 mm	4-0	BLUE	45		36	EH7759H

PROLENE* Monofilament Polypropylene







1/2 Circle Reverse Cutting Needles

Needle	Gauge	Suture Color	Length (cm)	Other information	Number per box	Code
 J-1 17 mm	3-0	BLUE	45		36	EH7545H
 CP-2 26 mm	2-0	BLUE	75		36	F2819



Straight Cutting Needles

Needle	Gauge	Suture Color	Length (cm)	Other information	Number per box	Code
 SC-1 13 mm	4-0	BLUE	45		36	EH7730H
 KS 60 mm	3-0	BLUE	75		36	8622H
	2-0	BLUE	75		36	8623H

3/8 Circle Taper Point Needles Special





Needle	Gauge	Suture Color	Length (cm)	Other information	Number per box	Code
 BV75-3 3,8 mm	10-0	BLUE	13	75 microns	12	W2790
 BV130-4 4,7 mm	9-0	BLUE	13	150 microns	12	W2780
	8-0	BLUE	13	150 microns	12	W2779
 BV75-4 4,8 mm	10-0	BLUE	10	75 microns	12	EH7595G
 BV100-4 5,1 mm	10-0	BLUE	13	100 microns	12	W2794
	9-0	BLUE	13	100 microns	12	W2783
 BV100-4  BV100-4 5,1 mm	9-0	BLUE	45	100 microns	12	F1891
 BV-2 6,5 mm	9-0	BLUE	15	150 microns	12	EH7597G

1/4 Circle TAPERCUT* Needles

Needle	Gauge	Suture Color	Length (cm)	Other information	Number per box	Code
 CIF-4  CIF-4 13 mm	10-0	BLUE	20	200 microns	12	788G

PROLENE* Monofilament Polypropylene

3/8 Circle MICROPOINT* Spatula

Needle	Gauge	Suture Color	Length (cm)	Other information	Number per box	Code	
 GS-12	5,5 mm	10-0	BLUE	30	150 microns	12	EH7473G
 GS-12 GS-12	5,5 mm	10-0	BLUE	30	150 microns	12	EH7598G
 CS-35-C CS-35-C	6 mm	10-0	BLUE	30	150 microns	12	EH7984G
 TG140-6 TG140-6	6,5 mm	10-0	BLUE	30	150 microns	12	W1777
 GS-9 GS-9	6,5 mm	9-0	BLUE	15	200 microns	12	1754G



1/4 Circle CS ULTIMA* Spatula

Needle	Gauge	Suture Color	Length (cm)	Other information	Number per box	Code	
 CTC-6 L	13 mm	10-0	BLUE	10	150 microns	12	EH7897G

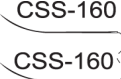
Ski MICROPOINT* Spatula

Needle	Gauge	Suture Color	Length (cm)	Other information	Number per box	Code	
 CSS-160 CSS-160	16 mm	10-0	BLUE	30	150 microns	12	EH7997G

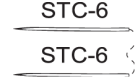
Straight MICROPOINT* Spatula

Needle	Gauge	Suture Color	Length (cm)	Other information	Number per box	Code	
 STC-6 STC-6	16 mm	10-0	BLUE	20		12	1713G
 STC-6	16 mm	10-0	BLUE	15	Loop	12	EH7900G

Special Combinations

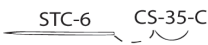
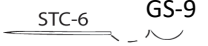
Needle	Gauge	Suture Color	Length (cm)	Other information	Number per box	Code	
 STC-6 CS-35-C	16 mm + 6 mm	10-0	BLUE	20		12	ET5631SG
 STC-6 GS-9	6,5 mm + 16 mm	9-0	BLUE	20		12	1753G

ETHILON*

(Polyamide 6) Suture



ETHILON*

Monofilament Polyamide 6

SUTURE

Description: **Monofilament** For smooth passage through tissue.
 Synthetic For minimal tissue reaction.
 Non-absorbable Provides prolonged tensile strength retention in tissue.

Color: Blue, black or clear.

Range: 11-0 to 2 (USP). Supplied as needled sutures armed with, for example, MULTIPASS* and PRIME* needles. ETHILON* is also available as ligatures.

Indications: ETHILON* (black and clear) sutures are intended for use in general soft tissue approximation and/or ligation, including use in cardiovascular, ophthalmic, microsurgical and neurosurgical procedures. Blue ETHILON* sutures are intended for use in skin closure. Typical areas of use include:









- Cuticular sutures
- Nerve adaptation
- Ophthalmology

Full details in the Instruction for Use included in every package.



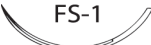



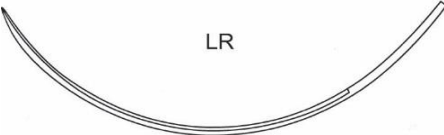



ETHILON* Monofilament Polyamide 6

3/8 Circle Reverse Cutting Needles

Needle		Gauge	Suture Color	Length (cm)	Other information	Number per box	Code
 C-2	13 mm	6-0	BLACK	45	250 microns	36	667H
		5-0	BLACK	45	250 microns	36	668H
 M-2	13 mm	5-0	BLACK	45	360 microns	36	644H
 FS-3	16 mm	6-0	BLACK	45		36	660H
		6-0	BLACK	45	VISI-BLACK*	36	EH7177H
		5-0	BLACK	45		36	1628H
		4-0	BLACK	45		36	1162H
 FS-2	19 mm	5-0	BLACK	45		36	661H
		4-0	BLUE	45		36	EH7144H
		4-0	BLACK	75		36	EH7143BH
		3-0	BLACK	45		36	653H
		2-0	BLUE	90		36	F3217
 FS-2S	19 mm	4-0	BLACK	45	Slimmed	36	662SLH
 FS-1	24 mm	5-0	BLACK	45		36	EH7640H
		4-0	BLACK	45		36	1629H
		4-0	BLACK	75		36	FJ5272BH
		3-0	BLACK	45		36	663H
		3-0	BLACK	75		36	669H
		3-0	BLACK	90		36	F2417H
		2-0	BLACK	45		36	EH7826BH
		2-0	BLUE	75		36	EH7827H
 FS	26 mm	4-0	BLACK	45		12	W345BG
		3-0	BLACK	45		12	W320BG
		2-0	BLACK	45		36	664H
 FSL	30 mm	4-0	BLACK	75		36	1670BH
		3-0	BLACK	45		36	1171H
		3-0	BLACK	75		36	1671H
		3-0	BLACK	45		36	S2455
		2-0	BLUE	75		36	EH7798H
		3-0	BLACK	75		36	1673BH
 FSLX	36 mm	2-0	BLUE	75		36	1674H
		0	BLACK	75		36	P7085H
		3-0	BLACK	75		36	1673BH
 FSLY	45 mm	2-0	BLACK	100		12	W736G
 LR	76 mm	2	BLACK	3x50		12	3460TG



ETHILON* Monofilament Polyamide 6

3/8 Circle Reverse Cutting PRIME* Needles

Needle		Gauge	Suture Color	Length (cm)	Other information	Number per box	Code
 P-6	8 mm	7-0	BLACK	45		36	1647H
 P-1	11 mm	7-0	BLACK	45		36	1696H
		7-0	BLACK	45	MULTIPASS*	36	MPE1696H
		6-0	BLACK	45		36	697H
		6-0	BLACK	45	MULTIPASS*	36	MPE697H
		5-0	BLACK	45		24	W1611T
 P-3	13 mm	6-0	BLACK	45	MULTIPASS*	36	1698H
		5-0	BLACK	45	MULTIPASS*	36	698H
		4-0	UNDYED	45		36	691H
		4-0	BLACK	45	MULTIPASS*	36	699H
 PS-3	16 mm	6-0	BLACK	45	MULTIPASS*	12	1665G
		5-0	BLACK	45	MULTIPASS*	36	1668H
		4-0	BLACK	45	MULTIPASS*	36	EH7761H
		4-0	BLUE	75		36	JD5273H
 PS-2	19 mm	5-0	BLACK	45	MULTIPASS*	36	1666H
		4-0	BLUE	45		36	EH7162H
		4-0	BLUE	45		24	W1620T
		4-0	BLUE	45	MULTIPASS*	36	MPE1855H
		4-0	UNDYED	45		12	1611G
		3-0	BLACK	45	MULTIPASS*	36	1669H
 PS-2 S	19 mm	4-0	BLACK	45	MULTIPASS*	36	1667SLH
 PS-1	24 mm	4-0	BLACK	75	MULTIPASS*	36	EH7957BH
		3-0	BLACK	45		36	1663H
		3-0	BLACK	75	MULTIPASS*	36	EH7563H
 PS	26 mm	3-0	BLUE	45	MULTIPASS*	36	MPE1625H
		3-0	BLACK	45	MULTIPASS*	36	W1625BH
		3-0	BLACK	75	MULTIPASS*	36	W1685BH
		2-0	BLUE	75		24	W1626T
 PSL	30 mm	3-0	BLUE	75		36	EH7113H

ETHILON* Monofilament Polyamide 6

3/8 Circle Conventional Cutting PRIME* Needles

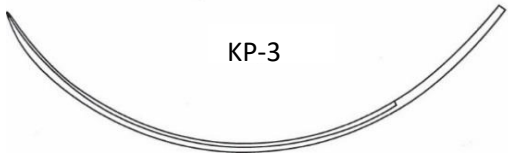
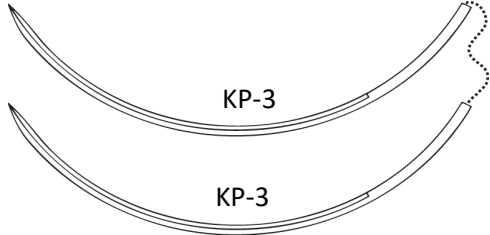
Needle		Gauge	Suture Color	Length (cm)	Other information	Number per box	Code
 PC-1	13 mm	6-0	BLACK	45		36	JM5140H
 PC-3	16 mm	6-0	BLACK	45	MULTIPASS*	12	1866G
		5-0	BLACK	45	MULTIPASS*	36	1865H
 PC-5	19 mm	4-0	BLACK	45	MULTIPASS*	12	1894G
 KP-3	90 mm	1	BLACK	2x50	With retention tubing	12	W2797
 KP-3 KP-3	90 mm	1	BLACK	75		12	W689

1/2 Circle Reverse Cutting Needles

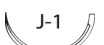
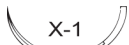

Needle		Gauge	Suture Color	Length (cm)	Other information	Number per box	Code
 M-1	13 mm	5-0	BLACK	45		36	648H
 J-1	17 mm	5-0	BLACK	75		36	F2423H
 X-1	22 mm	3-0	BLACK	45		12	642G
 CPX	48 mm	1	BLACK	100		12	W738G

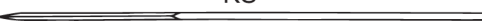
Straight Cutting Needles





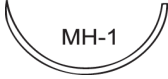







Needle		Gauge	Suture Color	Length (cm)	Other information	Number per box	Code
 KS	60 mm	3-0	BLACK	75		36	627H
		2-0	BLACK	75		36	628H

ETHILON* Monofilament Polyamide 6

1/2 Circle Taper Point Needles



Needle		Gauge	Suture Color	Length (cm)	Other information	Number per box	Code
 MH-1	31 mm	0	BLACK	150	Loop	12	W739
 CTX	48 mm	1	BLACK	150	Loop	12	W748

3/8 Circle Taper Point Needles



Needle		Gauge	Suture Color	Length (cm)	Other information	Number per box	Code
 BV130-3	3,7 mm, 150 microns	9-0	BLACK	13		12	FG2819
 BV75-3	3,8 mm, 75 microns	10-0	BLACK	13		12	W2870
		9-0	BLACK	13		12	W2871
 BV50-3	3,8 mm, 50 microns	11-0	BLACK	13		12	W2881
 BV130-4	4,7 mm, 150 microns	9-0	BLACK	13		12	W2813
		8-0	BLACK	13		12	W2812
 BVH100-3	5 mm, 100 microns	10-0	BLACK	13	1/2 circle	12	W2860
 BV75-4	5,1 mm, 75 microns	10-0	BLACK	13		12	W2850
 BV100-4	5,1 mm, 100 microns	10-0	BLACK	13		12	W2830
		10-0	BLACK	15		12	2814G
		9-0	BLACK	13		12	W2829
		9-0	BLACK	15		12	EH7448G
 BV-2	6,5 mm, 150 microns	10-0	BLACK	15		12	2810G
		9-0	BLACK	15		12	2809G
 BV130-5	6,5 mm, 150 microns	10-0	BLACK	13		12	W2810
		8-0	BLACK	15	MULTIPASS*	12	2808G
		8-0	BLACK	13		12	W2808
 BV130-5	6,5 mm, 150 microns	10-0	BLACK	30		12	W2801
 BV-1	9,3 mm, 250 microns	8-0	BLACK	45		12	W8170
 BV-1	9,3 mm, 250 microns	7-0	BLACK	45		36	EH7446H

ETHILON* Monofilament Polyamide 6

3/8 Circle CS ULTIMA* Spatula

Needle		Gauge	Suture Color	Length (cm)	Other information	Number per box	Code
CS-140-6 	6,5 mm, 150 microns	10-0	BLACK	15		12	7060G
		10-0	BLACK	30		12	U7061
CS-140-6 	6,5 mm, 150 microns	10-0	BLACK	30		12	U7003



3/8 Circle MICROPOINT* Spatula

Needle		Gauge	Suture Color	Length (cm)	Other information	Number per box	Code
CS-35-C 	6 mm, 150 microns	10-0	BLACK	15		12	EH7980G
GS-9 	6,5 mm, 200 microns	10-0	BLACK	30		12	1718G
		9-0	BLACK	30		12	1717G
TG140-6  TG140-6	6,5 mm, 150 microns	11-0	BLACK	30		12	W1780
		10-0	BLACK	30		12	W1770
		9-0	BLACK	30		12	W1769

1/2 Circle MICROPOINT* Reverse Cutting Needles

Needle		Gauge	Suture Color	Length (cm)	Other information	Number per box	Code
G-7 	8 mm	8-0	BLACK	45		12	W1765

1/2 Circle MICROPOINT* Spatula

Needle		Gauge	Suture Color	Length (cm)	Other information	Number per box	Code
TG160-6 	5,5 mm, 150 microns	10-0	BLACK	30		12	W1756
TG175-8 	7 mm, 200 microns	8-0	BLACK	30		12	1716G

1/2 Circle CS ULTIMA* Spatula

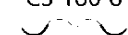

Needle		Gauge	Suture Color	Length (cm)	Other information	Number per box	Code
CS-160-6 	5,5 mm, 150 microns	10-0	BLACK	30		12	U7000

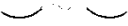
1/4 Circle MICROPOINT* Spatula

Needle		Gauge	Suture Color	Length (cm)	Other information	Number per box	Code
TG100-8 	6,5 mm, 220 microns	8-0	BLACK	30		12	B7714

ETHILON* Monofilament Polyamide 6

1/4 Circle Spatula Needles

		Gauge	Suture Color	Length (cm)	Other information	Number per box	Code	
S-14 	S-14 	8 mm	5-0	BLACK	30	200 microns	12	B7712

1/4 Circle TAPERCUT* Needles

		Gauge	Suture Color	Length (cm)	Other information	Number per box	Code
V100-3 	3,5 mm, 100 microns	10-0	BLACK	13		12	W2899
		9-0	BLACK	13		12	W2898
V150-4 	4,5 mm, 150 microns	10-0	BLACK	15		12	W1701

Ligatures

		Gauge	Suture Color	Length (cm)	Other information	Number per box	Code
LIGAPAK*		2-0	BLACK	250	Reel	20	F4354

ETHIBOND* Excel

(Polybutylate Coated Polyester) Suture



ETHICON

PART OF THE *Johnson & Johnson* FAMILY OF COMPANIES

ETHIBOND* Excel

Polybutylate Coated Polyester

SUTURE

Description:

Braided Coated	For easy handling and secure knot tying. For smooth tie down and easy passage through tissue.
Synthetic	For minimal tissue reaction.
Non-absorbable	Provides permanent tensile strength retention in tissue.

Color:

Green or white.

Range:

7-0 to 6 (USP). Supplied as needled sutures or ligatures. With or without pledgets.

Indications:

ETHIBOND* sutures are intended for use in general soft tissue approximation and/or ligation, including use in cardiovascular, ophthalmic and neurosurgical procedures. Typical areas of use include:











- Heart valve fixation
- Ligament and tendon repair
- Retraction sutures

Full details in the Instruction for Use included in every package.





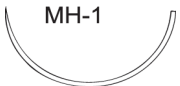

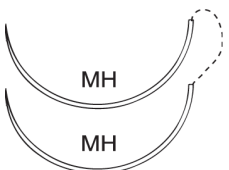

ETHIBOND* Excel Multifilament Coated Polyester

1/2 Circle Taper Point Needles



Needle		Gauge	Suture Color	Length (cm)	Other information	Number per box	Code
	13 mm	5-0	GREEN	75	400 microns	36	6710H
	13 mm	4-0	GREEN	75	450 microns	36	EH7417H
	13 mm	4-0	GREEN	45	Pledget 10x4mm	36	EH7420H
	17 mm	5-0	GREEN	75		36	6870H
		4-0	GREEN	75		36	6871H
		3-0	GREEN	75		36	6872H
		2-0	GREEN	75		36	6873H
	17 mm	5-0	GREEN	75		36	6550H
		4-0	GREEN	75		36	E6551H
		3-0	GREEN	90		36	6558H
		2-0	GREEN	90		12	W6760
	22 mm	4-0	GREEN	75		36	EH7397H
		3-0	GREEN	75		36	EH7398H
		2-0	GREEN	75		36	EH7399H
	22 mm	3-0	GREEN	90		36	E6762H
	26 mm	4-0	GREEN	75		36	W6831
		3-0	GREEN	75		36	6832H
		2-0	GREEN	75		36	6833H
		0	GREEN	75		36	6834H
		0	GREEN	120		36	PF6315H
		1	GREEN	75		36	EH7528H
	26 mm	4-0	GREEN	90		36	6521H
		3-0	GREEN	90		36	6522H
		2-0	GREEN	90		36	6523H
		2-0	GREEN/WHITE	10x75		6	W10B82
		0	GREEN	90		36	X524H
	31 mm	0	GREEN	75		12	W975G
	36 mm	2-0	GREEN	75		36	EH7490H
		0	GREEN	75		36	EH7491H
	36 mm	2-0	GREEN	90		36	B843H

ETHIBOND* Excel Multifilament Coated Polyester

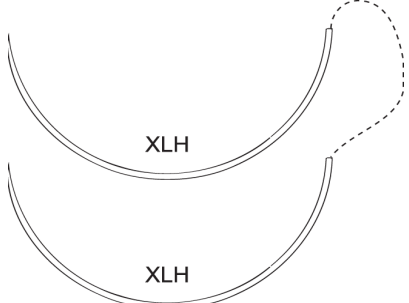
1/2 Circle Taper Point Needles (Heavier Wire Diameter)

		Gauge	Suture Color	Length (cm)	Other information	Number per box	Code
	13 mm	1	GREEN	75		36	X7497H
	22 mm	2	GREEN	75		36	EH7845H
	26 mm	2-0	GREEN	75		36	X411H
		0	GREEN	75		36	X412H
	26 mm	2	GREEN	75		36	TB6377H
		2	GREEN/WHITE	4x75		24	4TB7177E
	31 mm	2	GREEN	75		36	TC6377H
	36 mm	0	GREEN	75		36	X424H
		1	GREEN	75		36	X425H
	48 mm	1	GREEN	75		36	PN6376H
	70 mm	1	GREEN	75		12	X190G

3/8 Circle Taper Point Needles



Needle	Gauge	Suture Color	Length (cm)	Other information	Number per box	Code	
		5-0	GREEN	75		36	6890H
	17 mm	4-0	GREEN	75		36	6881H

ETHIBOND* Excel Multifilament Coated Polyester

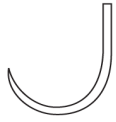
Fish Hook Taper Point Needles



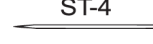

Needle		Gauge	Suture Color	Length (cm)	Other information	Number per box	Code
 ASH-30	30 mm	1	GREEN	75		12	W969

Straight Taper Point Needles

Needle		Gauge	Suture Color	Length (cm)	Other information	Number per box	Code
 ST-4 ST-4	19 mm	4-0	GREEN	35		36	EH7418H
 ST-4		3-0	GREEN	45		36	EH7733H
 STAW STAW	65 mm	0	GREEN	75		24	BLL6375E
 STA STA	65 mm	3	GREEN	75		12	X7479G





ETHIBOND* Excel Multifilament Coated Polyester

1/2 Circle TAPERCUT* Needles

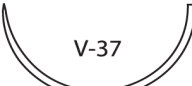

Needle		Gauge	Suture Color	Length (cm)	Other information	Number per box	Code
 V-5	17 mm	5-0	GREEN	75		36	6951H
		4-0	GREEN	75		36	EH7384H
		3-0	GREEN	75		36	6953H
		2-0	GREEN	75		36	6954H
 V-5 V-5	17 mm	4-0	GREEN	75		36	6935H
		4-0	GREEN/WHITE	4x75		12	MEH7719LG
		3-0	GREEN	75		36	6936H
		2-0	GREEN	75		36	6937H
		2-0	GREEN	75	6x3 mm pledgets	36	P6937H
		2-0	GREEN/WHITE	4x75		12	EH7712LG
		2-0	GREEN/WHITE	4x75	6x3 mm pledgets	12	EH7715LG
		2-0	GREEN	8x75	6x3 mm pledgets	6	MEH6937N
		2-0	GREEN/WHITE	8x75		6	MEH7712N
		2-0	GREEN/WHITE	8x75	6x3 mm pledgets	6	MEH7715N
		2-0	GREEN/WHITE	10x75	3x3 mm pledgets	6	W10B54
		2-0	WHITE	90		12	W6917
		2-0	GREEN	90	3x3 mm pledgets	36	D9813
		2-0	WHITE	90	3x3 mm pledgets	36	D9814
		2-0	GREEN/WHITE	4X90	6x3 mm pledgets	12	MEH7718LG
2-0	GREEN/WHITE	10X90		6	KV33		
 V-6 V-6	22 mm	2-0	GREEN	90		36	X32019
 V-7	26 mm	3-0	GREEN	75		36	6963H
		2-0	GREEN	75		36	6964H
		0	GREEN	75		36	6965H
 V-7 V-7	26 mm	3-0	GREEN	75		36	6976H
		2-0	GREEN	75		36	6977H
		2-0	WHITE	75		36	6987H
		2-0	GREEN	90		12	W6977
		2-0	GREEN	75	6x3 mm pledgets	36	P6977H
		2-0	GREEN/WHITE	4x75		12	EH7711LG
		2-0	GREEN/WHITE	4x75	6x3 mm pledgets	12	EH7716LG
		2-0	GREEN/WHITE	8x75	6x3 mm pledgets	6	MEH7716N
		2-0	GREEN/WHITE	10x75	6x3 mm pledgets	6	W10B77
		2-0	GREEN/WHITE	10X75	3x3 mm soft pledgets	12	PX1008
		2-0	GREEN/WHITE	10x90	6x3 mm pledgets	6	KV91
		2-0	GREEN/WHITE	10x90		6	KV31
		2-0	GREEN/WHITE	4X90	6x3 mm pledgets	12	MEH7710LG
		0	GREEN	90		12	X905G
0	GREEN/WHITE	8x90	6x3 mm pledgets	6	MEH7717N		

ETHIBOND* Excel Multifilament Coated Polyester



1/2 Circle TAPERCUT* Needles (Heavier Wire Diameter)

Needle		Gauge	Suture Color	Length (cm)	Other information	Number per box	Code
 V-34	36 mm	1	GREEN	90		36	EB4407H
 V-37	40 mm	2	GREEN	75		12	869G
		6	GREEN	75		12	X32082G
 V-39	45 mm	2	GREEN	4x75		12	X4843G
 V-40	48 mm	6	GREEN	75		12	RS71G
 V-55	55 mm	5	GREEN	75		12	BE3294G
		5	GREEN	4x75		12	W4846

3/8 Circle TAPERCUT* Needles







Needle		Gauge	Suture Color	Length (cm)	Other information	Number per box	Code
 V-4	17 mm	4-0	GREEN	75		36	E6942H
		3-0	GREEN	75		36	6943H
		2-0	GREEN	75		36	6944H
 V-4	17 mm	2-0	GREEN	75		36	X927H
		2-0	GREEN	90	6x3 mm pledgets	36	X32200

Compound Curve TAPERCUT* Needles



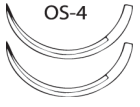

Needle		Gauge	Suture Color	Length (cm)	Other information	Number per box	Code
 DA-1	13 mm	4-0	GREEN	45	VISI-BLACK*	12	18537G
 DA	25 mm	4-0	GREEN	45	VISI-BLACK*	12	18536G

ETHIBOND* Excel Multifilament Coated Polyester

1/2 Circle Reverse Cutting Needles

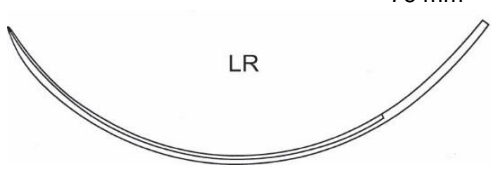

Needle	Gauge	Suture Color	Length (cm)	Other information	Number per box	Code	
 X-1	22 mm	2-0	GREEN	75		36	EH7679H
 OS-4	22 mm	0	GREEN	75		36	X517H
		1	GREEN	75		36	X518H
 OS-4	22 mm	2	GREEN	90		12	W6748
 CP-2	26 mm	0	GREEN	75		36	EH7673H
 CP-1	36 mm	0	GREEN	75		36	X32049
		1	GREEN	75		36	EH7674H
 CP		3	GREEN	75		36	X32071

3/8 Circle Reverse Cutting Needles

Needle	Gauge	Suture Color	Length (cm)	Other information	Number per box	Code	
 FS-2	19 mm	5-0	GREEN	45		36	6661H
		3-0	GREEN	45		36	EH7346H
 FS-2S	19 mm	4-0	GREEN	45	Slimmed	36	6683H
 FSL	30 mm	0	GREEN	75		36	EH7688H
 FSLX	36 mm	0	GREEN	75		36	EH7562H
 LR	76 mm	5	GREEN	50		12	B409TG

ETHIBOND* Excel Multifilament Coated Polyester

3/8 Circle Reverse Cutting PRIME* Needles

Needle		Gauge	Suture Color	Length (cm)	Other information	Number per box	Code
 P-3	13 mm	5-0	GREEN	45		12	X698G
		4-0	GREEN	45		36	EH7573H
		4-0	WHITE	45		36	JA6442H
 PS-3	16 mm	5-0	GREEN	45		36	6681H
		4-0	GREEN	45		36	EH7760H

Straight Cutting Needles

Needle		Gauge	Suture Color	Length (cm)	Other information	Number per box	Code
 KS	60 mm	3-0	GREEN	75		36	EH7722H
		1	GREEN	75		36	X32030H

Ski Cutting Needles

Needle		Gauge	Suture Color	Length (cm)	Other information	Number per box	Code
 PB-1	22 mm	3-0	GREEN	45		36	EH7579H

ETHIBOND* Excel Multifilament Coated Polyester

Ligatures

Ligatures						
	Gauge	Suture Color	Length (cm)	Other information	Number per box	Code
LIGAPAK*	5	GREEN	125	REEL	20	SP4491
SUTUPAK*	3-0	GREEN	2x70		36	EH6453H
	2-0	GREEN	2x70		36	EH6454H
	0	GREEN	2x70		36	EH6455H
	1	GREEN	2x70		36	EH6456H
	2	GREEN	2x70		36	EH6457H
	3	GREEN	2x70		36	EH6458H
	5	GREEN	2x70		36	EH6459H
SUTUPAK*	2-0	GREEN	3x45		36	EH6434H
	2	GREEN	3x45		36	EH6437H
SUTUPAK*	3-0	GREEN	5x70		36	EH6523H
	2-0	GREEN	5x70		36	EH6524H
	0	GREEN	5x70		36	EH6525H
	1	GREEN	5x70		36	EH6526H
SUTUPAK*	5-0	GREEN	6x45		36	EH6441H
	4-0	GREEN	6x45		36	EH6442H
	3-0	GREEN	6x45		36	EH6443H
	0	GREEN	6x45		36	EH6445H
	1	GREEN	6x45		36	EH6446H
SUTUPAK*	4-0	GREEN	12x45		36	EH6372H
	2-0	GREEN	12x45		36	EH6374H
	0	GREEN	12x45		24	EH6375E

MERSILENE*

(Polyester) Suture



ETHICON

PART OF THE *Johnson & Johnson* FAMILY OF COMPANIES

MERSILENE*

Polyester

SUTURE

Description:

Braided	For easy handling and secure knot tying.
Synthetic	For minimal tissue reaction.
Non-absorbable	Provides permanent tensile strength retention in tissue.

Color:

Green or white.

Range:

10-0 to 3 (USP). Supplied as needed sutures or ligatures. Size 10-0 is monofilament in structure.

Indications:

MERSILENE* sutures are intended for use in general soft tissue approximation and/or ligation, including use in cardiovascular, ophthalmic and neurosurgical procedures. Typical areas of use include:



- Dental surgery
- Ophthalmic surgery
- Ligation

Full details in the Instruction for Use included in every package.



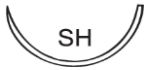

MERSILENE* Polyester Multifilament Suture

1/2 Circle Taper Point Needles

Needle	Gauge	Suture Color	Length (cm)	Other information	Number per box	Code	
 RB-1	17 mm	3-0	GREEN	75		36	R872H
 SH	26 mm	3-0	GREEN	75		36	R832H
		2-0	GREEN	75		36	R833H
		0	GREEN	75		36	R834H
		1	GREEN	75		36	EH7526H
 MH	36 mm	2-0	GREEN	75		36	R843H
		0	GREEN	75		36	R844H
		1	GREEN	75		36	R845H
 CT-1	36 mm	0	GREEN	75		36	R424H

1/2 Circle TAPERCUT* Needles

Needle	Gauge	Suture Color	Length (cm)	Other information	Number per box	Code	
 V-5	17 mm	4-0	GREEN	45		12	18513G
		3-0	GREEN	45		12	18506G
 V-7	26 mm	2-0	GREEN	75		36	R964H



3/8 Circle TAPERCUT* Needles

Needle	Gauge	Suture Color	Length (cm)	Other information	Number per box	Code	
 V-4	17 mm	3-0	GREEN	75		36	R943H

Compound Curve TAPERCUT* Needles

Needle	Gauge	Suture Color	Length (cm)	Other information	Number per box	Code	
 DA	25 mm	4-0	GREEN	45	VISI-BLACK*	12	18528G

1/2 Circle Reverse Cutting Needles





Needle	Gauge	Suture Color	Length (cm)	Other information	Number per box	Code	
 CP-2	26 mm	0	GREEN	75		36	EH7325H
 CP-1	36 mm	1	GREEN	75		36	EH7350H

MERSILENE* Polyester Multifilament Suture

3/8 Circle Reverse Cutting PRIME* Needles

Needle	Gauge	Suture Color	Length (cm)	Other information	Number per box	Code	
 P-3	13 mm	4-0	WHITE	45		36	R691H

3/8 Circle Reverse Cutting Needles

Needle	Gauge	Suture Color	Length (cm)	Other information	Number per box	Code	
 FS-3	16 mm	5-0	GREEN	45		36	R670H
 FS-2	19 mm	4-0	GREEN	45		36	EH7147H
		4-0	WHITE	45		36	EH7148H
 FS-2S	19 mm	4-0	WHITE	45	Slimmed	36	R633H
 FS-1	24 mm	3-0	GREEN	45		36	EH7684H
		3-0	WHITE	45		36	R647H
		2-0	GREEN	45		36	EH7683H
 FS	26 mm	2-0	WHITE	45		36	R665H
 FSL	30 mm	2-0	GREEN	75		36	EH7638H
		2-0	WHITE	45		36	R677H
		0	GREEN	75		36	EH7637H



3/8 Circle MICROPPOINT* Spatula

Needle	Gauge	Suture Color	Length (cm)	Other information	Number per box	Code	
 TG140-6 TG140-6	6,5 mm	10-0	GREEN	30	Monofilament	12	W1775

1/2 Circle Spatula Needles

Needle	Gauge	Suture Color	Length (cm)	Other information	Number per box	Code	
 S-22	8 mm	5-0	WHITE	45		12	1765G

1/4 Circle Spatula Needles

Needle	Gauge	Suture Color	Length (cm)	Other information	Number per box	Code	
 S-14	8 mm	6-0	WHITE	45		12	1722G
		5-0	WHITE	45		12	1760G
 RD-1	8 mm	5-0	WHITE	45	Center point spatula	12	746G

1/4 Circle Conventional Spatula Needles

Needle	Gauge	Suture Color	Length (cm)	Other information	Number per box	Code	
 S-4	8 mm	4-0	WHITE	45		12	1778G

MERSILENE* Polyester Multifilament Suture

Ligatures

Needle	Gauge	Suture Color	Length (cm)	Other information	Number per box	Code
SUTUPAK*	0	GREEN	2x70		36	EH6885H
	1	GREEN	2x70		36	EH6886H
	2	GREEN	2x70		36	EH6887H
SUTUPAK*	3-0	GREEN	3x45		36	EH6853H
	0	GREEN	3x45		36	EH6855H
	1	GREEN	3x45		36	EH6856H
	2	GREEN	3x45		36	EH6857H
	3	GREEN	3x45		36	EH6858H
SUTUPAK*	3-0	GREEN	6x45		36	EH6733H
	2-0	GREEN	6x45		36	EH6734H
	1	GREEN	6x45		36	EH6736H
SUTUPAK*	3-0	GREEN	12x45		36	EH6663H
	1	GREEN	12x45		24	EH6666E
LIGAPAK*	2-0	GREEN	250	Ligature reel	20	F4503
	0	GREEN	250	Ligature reel	20	F4504
	1	GREEN	250	Ligature reel	20	F4505
	2	GREEN	250	Ligature reel	20	F4506
	3	GREEN	250	Ligature reel	20	F4507

PRONOVA*

(Poly(hexafluoropropylene-VDF)) Suture

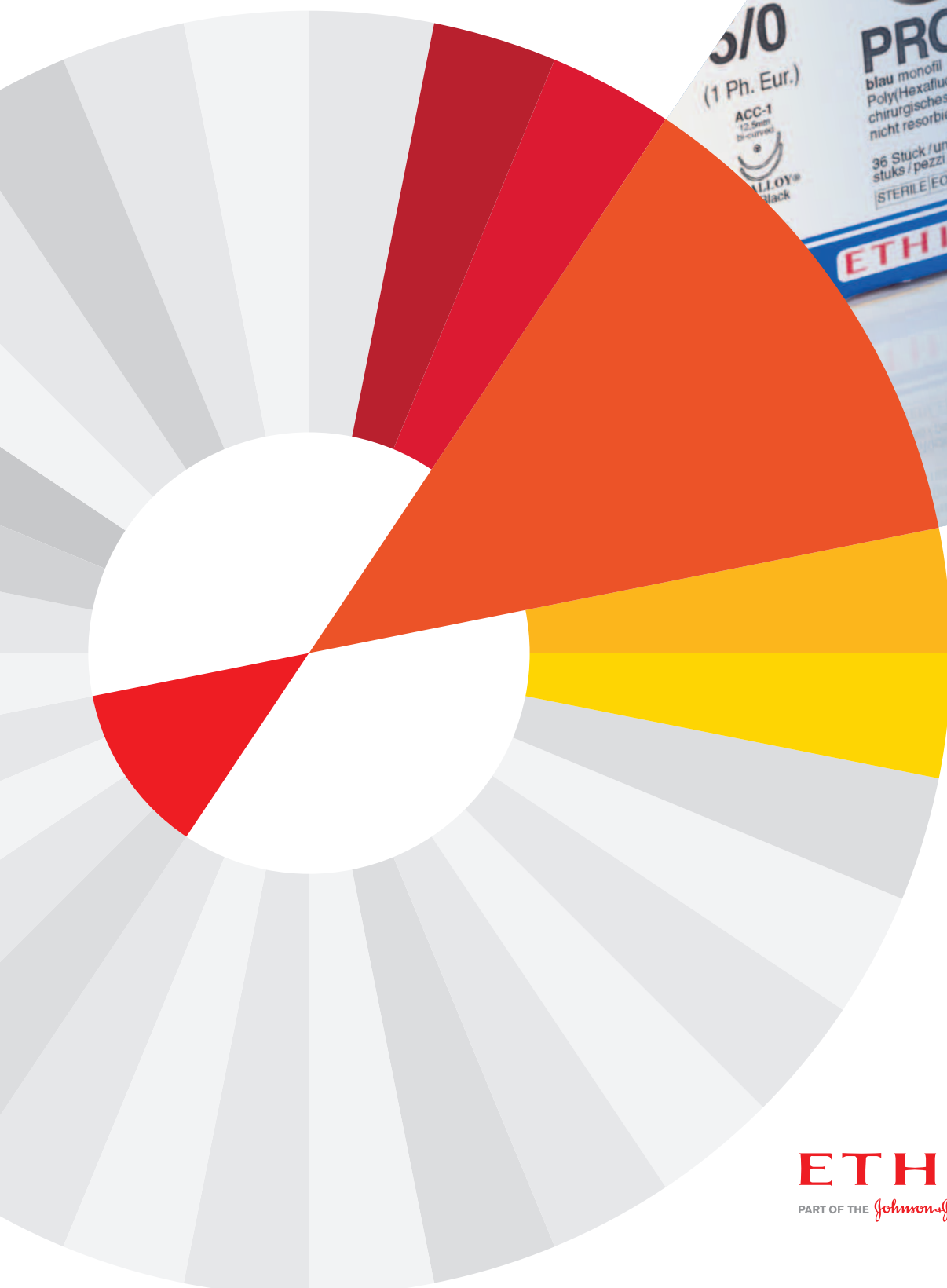

PRONOVA*

Poly(hexafluoropropylene-VDF)

SUTURE

Description: **Monofilament** For smooth passage through tissue.
 Synthetic For minimal tissue reaction.
 Non-absorbable Provides permanent tensile strength retention in tissue.

Color: Blue.

Range: 8-0 to 5-0 (USP). Supplied as needled sutures, armed with, for example, VISI-BLACK* needles or CC-needles.

Indications: PRONOVA* sutures are intended for use in general soft tissue approximation and/or ligation, including use in cardiovascular, ophthalmic and neurosurgical procedures. Typical areas of use include:



- Vascular anastomoses

Full details in the Instruction for Use included in every package.







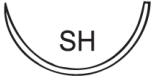

PRONOVA Poly(hexafluoropropylene-VDF) Monofilament



1/2 Circle Taper Point Needles

Needle	Gauge	Suture Color	Length (cm)	Other information	Number per box	Code	
	13 mm	6-0	BLUE	75		36	PN3711H
		5-0	BLUE	75		36	PN8500H
	17 mm	5-0	BLUE	75		36	PN1800H
		5-0	BLUE	90		36	PN8510H
	26 mm	5-0	BLUE	75		36	PN1821H
	26 mm	5-0	BLUE	75		36	PN1837H

3/8 Circle Taper Point Needles

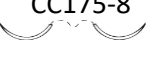

Needle	Gauge	Suture Color	Length (cm)	Other information	Number per box	Code
	6,5 mm	8-0	BLUE		12	PN1836LG
	6,5 mm	8-0	BLUE	VISI-BLACK*	24	PN8809LG
	8 mm	8-0	BLUE		12	PN1890G
		7-0	BLUE		36	PN1889H
	9,3 mm	7-0	BLUE		36	PN8709H
		7-0	BLUE		36	PN8714H
		7-0	BLUE	VISI-BLACK*	36	PN8706H
		7-0	BLUE	VISI-BLACK*	36	PN8700H
		6-0	BLUE	VISI-BLACK*	36	PN8613H
		6-0	BLUE	VISI-BLACK*	36	PN1852H
		6-0	BLUE		36	PN8612H
	13 mm	7-0	BLUE	VISI-BLACK*	36	PN8704H
		6-0	BLUE	VISI-BLACK*	36	PN1855H
		6-0	BLUE		36	PN8602H
		6-0	BLUE		36	PN8619H
		5-0	BLUE	VISI-BLACK*	36	PN1856H
		5-0	BLUE	VISI-BLACK*	36	PN8522H
	13 mm	5-0	BLUE		36	PN8502H
	17 mm	5-0	BLUE		36	PN1860H
		5-0	BLUE	VISI-BLACK*	36	PN1863H
		5-0	BLUE	VISI-BLACK*	36	PN1859H
		5-0	BLUE		36	PN1830H

3/8 Circle CC-Needles

Needle	Gauge	Suture Color	Length (cm)	Other information	Number per box	Code	
	9,3 mm	8-0	BLUE		12	PN8803LG	
		7-0	BLUE		36	PN1839H	
		6-0	BLUE		36	PN1809H	
	13 mm	6-0	BLUE		36	PN8605H	
		6-0	BLUE	75		36	PN1811H
		5-0	BLUE	75		36	PN1812H
		5-0	BLUE	90		36	PN8516H

PRONOVA Poly(hexafluoropropylene-VDF) Monofilament

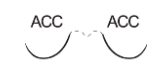
Compound Curve CC-Needles

Needle	Gauge	Suture Color	Length (cm)	Other information	Number per box	Code
 ACC ACC	9,3 mm	7-0	75	VISI-BLACK*	36	PN8715H
		6-0	75	VISI-BLACK*	36	PN8622H
 ACC-1 ACC-1	13 mm	6-0	75	VISI-BLACK*	36	PN8623H
		5-0	75	VISI-BLACK*	36	PN8529H

3/8 Circle TAPERCUT* Needles

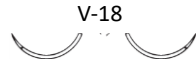
Needle	Gauge	Suture Color	Length (cm)	Other information	Number per box	Code
 V-18	13 mm	5-0	75		36	PN8520H

1/2 Circle TAPERCUT* Needles

Needle	Gauge	Suture Color	Length (cm)	Other information	Number per box	Code
 V-5 V-5	17 mm	5-0	75		36	PN2872H

MERSILK* / PERMA-HAND* SILK

Suture



2-0
(3 Ph. Eur.)

SH plus
26mm 1/2c

K833H
PERMA-HAND*SEIDE
schwarz geflochten
chirurgisches Nahtmaterial nicht resorbierbar

SETA
nera intrecciata sutura non assorbibile
MERSILK*
seda negra trenzada sutura no absorbible

36 Stück / pezzi / unidades
STERILE

LOT BA2BCDM0
2014-06

ETHICON®
ATRALOC®

2-0
(3 Ph. Eur.)
SH plus
26mm 1/2c

ETHIC
PERI
SEID
75cm
CE 0088

ETHICON

PART OF THE *Johnson & Johnson* FAMILY OF COMPANIES

SILK

Braided Silk / Virgin silk

SUTURE

Description:

Braided	For easy handling and secure knot tying.
Coated	With wax for easy handling.
Natural	Produced from cocoons of the silk worm <i>Bombyx Mori</i> .
Non-absorbable	Provides prolonged tensile strength retention in tissue for up to 3 months.

Color:

Black or white.

Range:

10-0 to 4 (USP). Supplied as needed sutures or ligatures. Sizes 10-0 to 8-0 are manufactured of virgin silk and are twisted in construction. Virgin silk fibres are held together by natural gum secreted by the silk worm.

Indications:

SILK sutures are intended for use in general soft tissue approximation and/or ligation, including use in cardiovascular, ophthalmic and neurosurgical procedures. Typical areas of use include:

- Ophthalmic surgery
- Dental surgery
- Ligation





Full details in the Instruction for Use included in every package.





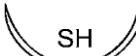
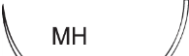

MERSILK* / PERMA-HAND* SILK

Braided Silk / Virgin silk

1/2 Circle Taper Point Needles

Needle		Gauge	Suture Color	Length (cm)	Other information	Number per box	Code
 TF	13 mm	5-0	BLACK	45		36	N266H
		4-0	BLACK	45		36	N267H
 RB-1	17 mm	5-0	BLACK	75		36	K870H
		4-0	BLACK	75		36	K871H
		3-0	BLACK	75		36	K872H
		2-0	BLACK	75		36	K873H
 SH-1	22 mm	3-0	BLACK	75		36	EH7343H
		2-0	BLACK	75		36	7344H
 SH	26 mm	4-0	BLACK	75		36	K831H
		3-0	BLACK	75		36	K832H
		2-0	BLACK	75		36	K833H
		0	BLACK	75		36	K834H
		1	BLACK	75		36	K835H
 MH	36 mm	2-0	BLACK	75		36	K843H
		0	BLACK	75		36	K844H
		1	BLACK	75		36	K845H
 CT-1	36 mm	2	BLACK	75		36	K846H

3/8 Circle Taper Point Needles

Needle		Gauge	Suture Color	Length (cm)	Other information	Number per box	Code
 BV-1	9,3 mm	7-0	BLACK	30		36	K803H
 C-1	13 mm	6-0	BLACK	75		36	K889H
		5-0	BLACK	75		36	K890H
		4-0	BLACK	75		36	K891H
 C-1 C-1	13 mm	6-0	BLACK	45		36	706H
 BB	17 mm	4-0	BLACK	75		36	K881H

Straight Taper Point Needles

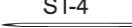
Needle		Gauge	Suture Color	Length (cm)	Other information	Number per box	Code
 ST-4	19 mm	4-0	BLACK	45		12	18507G
		4-0	BLACK	75		36	K861H

MERSILK* / PERMA-HAND* SILK



1/2 Circle TAPERCUT* Needles

Needle		Gauge	Suture Color	Length (cm)	Other information	Number per box	Code
 V-5	17 mm	4-0	BLACK	75		36	K952H
		3-0	BLACK	45		12	18514G
		3-0	BLACK	75		36	K953H
 V-7	26 mm	3-0	BLACK	75		12	K963G
		2-0	BLACK	75		36	K964H



3/8 Circle TAPERCUT* Needles

Needle		Gauge	Suture Color	Length (cm)	Other information	Number per box	Code
 V-4	17 mm	4-0	BLACK	75		36	K942H
		3-0	BLACK	45		12	FK9430



Compound Curve TAPERCUT* Needles

Needle		Gauge	Suture Color	Length (cm)	Other information	Number per box	Code
 DA-1	13 mm	4-0	BLACK	45	VISI-BLACK*	12	18534G
 DA	25 mm	4-0	BLACK	45	VISI-BLACK*	12	18529G

1/2 Circle Reverse Cutting Needles



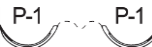



Needle		Gauge	Suture Color	Length (cm)	Other information	Number per box	Code
 J-1	17 mm	4-0	BLACK	45		12	18501G
		4-0	BLACK	45		36	734H
 X-1	22 mm	3-0	BLACK	45		12	18502G
		3-0	BLACK	45		36	632H
		2-0	BLACK	45		36	737H
 CP-1	36 mm	2-0	BLACK	75		36	443H

3/8 Circle Reverse Cutting PRIME* Needles

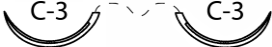
Needle		Gauge	Suture Color	Length (cm)	Other information	Number per box	Code
 P-1	11 mm	6-0	BLACK	45		36	639H
		6-0	BLACK	45		12	786G
 P-1 P-1	11 mm	6-0	BLACK	45		12	780G
 P-3	13 mm	5-0	BLACK	45		12	640G
		4-0	BLACK	45		12	18508G

MERSILK* / PERMA-HAND* SILK



3/8 Circle Reverse Cutting Needles

Needle		Gauge	Suture Color	Length (cm)	Other information	Number per box	Code
	13 mm	5-0	BLACK	45		36	719H
		4-0	BLACK	45		36	736H
		4-0	BLACK	45		12	W811
	13 mm	4-0	BLACK	30		36	735H
		4-0	WHITE	45		12	W816
	16 mm	6-0	BLACK	45		36	681H
	19 mm	5-0	BLACK	45		36	682H
		4-0	BLACK	45		12	EH7149G
		3-0	BLACK	45		36	EH7345H
	24 mm	4-0	BLACK	45		36	629H
		3-0	BLACK	45		36	684H
	26 mm	2-0	BLACK	45		36	685H
	30 mm	2-0	BLACK	45		12	677G
		2-0	BLACK	75		36	679H
		0	BLACK	75		36	680H
	36 mm	0	BLACK	75		36	EH7560H

3/8 Circle Conventional Cutting PRIME* Needles

Needle		Gauge	Suture Color	Length (cm)	Other information	Number per box	Code
	16 mm	6-0	BLACK	45		36	W529H
		5-0	BLACK	45		36	W528H
		4-0	BLACK	45		12	W604

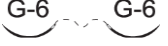
3/8 Circle MICROPPOINT* Reverse Cutting Needles

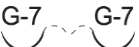

Needle		Gauge	Suture Color	Length (cm)	Other information	Number per box	Code
	8 mm	7-0	BLACK	30		12	EH7464G
		6-0	BLACK	30		12	EH7435G
	8 mm	7-0	BLACK	45		12	768G
		6-0	BLACK	45		12	769G
	13 mm	4-0	BLACK	45		12	783G

1/2 Circle MICROPPOINT* Reverse Cutting Needles

Needle		Gauge	Suture Color	Length (cm)	Other information	Number per box	Code
	8 mm	8-0	BLUE	45		12	W870
	8 mm	8-0	BLUE	45		12	W818

MERSILK* / PERMA-HAND* SILK

3/8 Circle MICROPPOINT* Spatula

Needle	Gauge	Suture Color	Length (cm)	Other information	Number per box	Code	
TG140-6  TG140-6	6,5 mm	8-0	BLUE	30		12	W1782
TG140-8  TG140-8	6,5 mm	8-0	BLUE	45		12	W1819

1/4 Circle Spatula Needles

Needle	Gauge	Suture Color	Length (cm)	Other information	Number per box	Code	
S-14  S-14	8 mm	6-0	BLACK	45		12	1780G
		5-0	BLACK	45		12	EH7440G

Ligatures

	Gauge	Suture Color	Length (cm)	Other information	Number per box	Code
LIGAPAK*	4-0	BLACK	366	Reel	12	LA53G
SUTUPAK*	2-0	BLACK	180			W193
	1	BLACK	180			W195
	2	BLACK	180			W196
SUTUPAK*	2	BLACK	2X150			SA8H
SUTUPAK*	3-0	BLACK	2x70		36	EH6833H
	0	BLACK	2x70		24	EH6835E
	1	BLACK	2x70		24	EH6836E
	2	BLACK	2x70		24	EH6837E
SUTUPAK*	3-0	BLACK	5x70		36	EH6823H
	2-0	BLACK	5x70		36	EH6824H
	0	BLACK	5x70		36	EH6825H
SUTUPAK*	4-0	BLACK	6X45		36	EH6712H
	3-0	BLACK	6X45		36	EH6713H
	2-0	BLACK	6X45		36	EH6714H
	2	BLACK	6X45		24	EH6717E
SUTUPAK*	2-0	BLACK	10x75		12	W223
	1	BLACK	10x75		12	W225
SUTUPAK*	4-0	BLACK	12x45		24	EH6722E
	3-0	BLACK	12x45		24	EH6723E
	2-0	BLACK	12x45		36	EH6724H
SUTUPAK*	4-0	BLACK	13x60		12	W211

STEEL

Suture



ETHICON
PART OF THE *Johnson & Johnson* FAMILY OF COMPANIES

STEEL

Monofilament and Multifilament

SUTURE

Description:

Multifilament or monofilament.

Non-absorbable Provides permanent tensile strength retention in tissue.

Color:

Undyed.

Range:

5-0 to 7 (USP). Supplied as needled sutures and ligatures. Also available as pull-out tendon suture with barb.

Indications:

STEEL sutures are intended for use in abdominal wall closure, hernia repair, sternal closure and orthopedic procedures including cerclage and tendon repair.

Typical areas of use include:

- Closure of sternum
- Pull-out tendon repair with the Bunnell technique

Full details in the Instruction for Use included in every package.







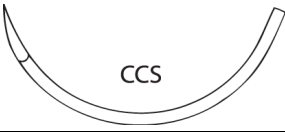
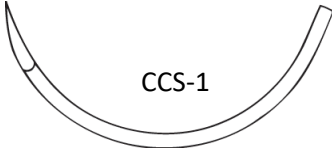

Stainless Steel Monofilament

1/2 Circle Conventional Cutting Needles (Heavier Wire Diameter)

Needle		Gauge	Suture Color	Length (cm)	Other information	Number per box	Code
 <p style="text-align: center;">CCS</p>	48 mm	5	Silver	4x45	Monofilament	12	MEH7210G
		6	Silver	4x45	Monofilament	12	653BG
		6	Silver	6x45	Monofilament	12	MEH7213G
		7	Silver	4x45	Monofilament	12	MEH7211G
 <p style="text-align: center;">CCS-1</p>	60 mm	5	Silver	2x75	Monofilament	12	M436C

1/2 Circle TAPERCUT* Needles

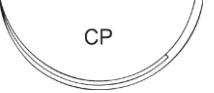
Needle		Gauge	Suture Color	Length (cm)	Other information	Number per box	Code
 <p style="text-align: center;">V-37</p>	40 mm	1	Silver	4x45	Monofilament	12	M660G
 <p style="text-align: center;">V-40</p>	48 mm	4	Silver	4x45	Monofilament	12	M651G
		6	Silver	4x45	Monofilament	12	M649G
		6	Silver	6x45	Monofilament	10	MF6642
		6	Silver	7x45	Monofilament	10	MF6647

1/2 Circle Reverse Cutting Needles (Heavier Wire Diameter)							
Needle	Gauge	Suture Color	Length (cm)	Other information	Number per box	Code	
 X-1	22 mm	3-0	Silver	75	Monofilament	12	F2706
 CP-1	36 mm	3-0	Silver	50	Monofilament	12	BA0497
 CP	40 mm	1	Silver	75	Monofilament	12	F2711
 CPX	48 mm	5	Silver	45	Monofilament	12	EH7677G
		7	Silver	4x45	Monofilament	12	M624G
 CPXX	55 mm	5	Silver	6x45	Monofilament	12	MEH7216G
		5	Silver	2x75	Monofilament	12	W902

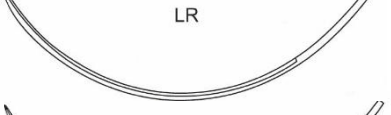
3/8 Circle Reverse Cutting Needles							
Needle	Gauge	Suture Color	Length (cm)	Other information	Number per box	Code	
 FS-2	19 mm	3-0	Silver	75	Monofilament	12	F2707
		4-0	Silver	45	Monofilament	12	603G
 LR	75 mm	2	Silver	75	Monofilament	12	D9803

Ligatures							
	Gauge	Suture Color	Length (cm)	Other information	Number per box	Code	
SUTUPAK*	2-0	Silver	6x45	Monofilament	12	F6714G	

NUROLON*

(Polyamide 6/6) Suture



NUROLON*

Polyamide 6/6

SUTURE

Description:

Braided	For easy handling and secure knot tying.
Coated	For easy passage through tissue.
Synthetic	For minimal tissue reaction.
Non-absorbable	Provides prolonged tensile strength retention in tissue.

Color:

Black.

Range:

5-0 to 1 (USP). Supplied as needed sutures or ligatures.

Indications:

NUROLON* sutures are intended for use in general soft tissue approximation and/or ligation, including use in cardiovascular, ophthalmic and neurosurgical procedures. Typical areas of use include:

- Drain fixation
- Ligation

Full details in the Instruction for Use included in every package.



NUROLON Braided Polyamide

1/2 Circle Taper point Needles

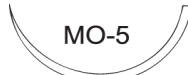
Needle		Gauge	Suture Color	Length (cm)	Other information	Number per box	Code
 TF	13 mm	4-0	BLACK	8x45	Control Release*	12	C584D
 MO-5	31 mm	1	BLACK	75		12	W5723

1/2 Circle TAPERCUT* Needles

Needle		Gauge	Suture Color	Length (cm)	Other information	Number per box	Code
 V-37	40 mm	0	BLACK	100		12	W5424
		1	BLACK	100		12	W5415

3/8 Circle Reverse Cutting Needles

Needle		Gauge	Suture Color	Length (cm)	Other information	Number per box	Code
 FS-2	19 mm	4-0	BLACK	45		36	NL106H
 FS	26 mm	2-0	BLACK	45		12	W5321

Ligatures

	Gauge	Suture Color	Length (cm)	Other information	Number per box	Code
SUTUPAK*	2-0	BLACK	3x45		36	EH6604H
SUTUPAK*	3-0	BLACK	10X75		12	W5222
	2-0	BLACK	10x75		12	W5223
	0	BLACK	10X75		12	W5224
	1	BLACK	10X75		12	W5225
SUTUPAK*	4-0	BLACK	12x45		36	EH6621H
	3-0	BLACK	12x45		36	EH6622H
	2-0	BLACK	12X45		36	EH6623H
	0	BLACK	12x45		24	EH6624E
	1	BLACK	12X45		24	EH6625E
	2	BLACK	12X45		24	EH6626E
SUTUPAK*	0	BLACK	17x45		12	W5204

Stratafix™

STRATAFIX™ Knotless Tissue Control Device

EMEA Portfolio Product Catalogue 2019/20

A versatile portfolio to meet your wound closure needs

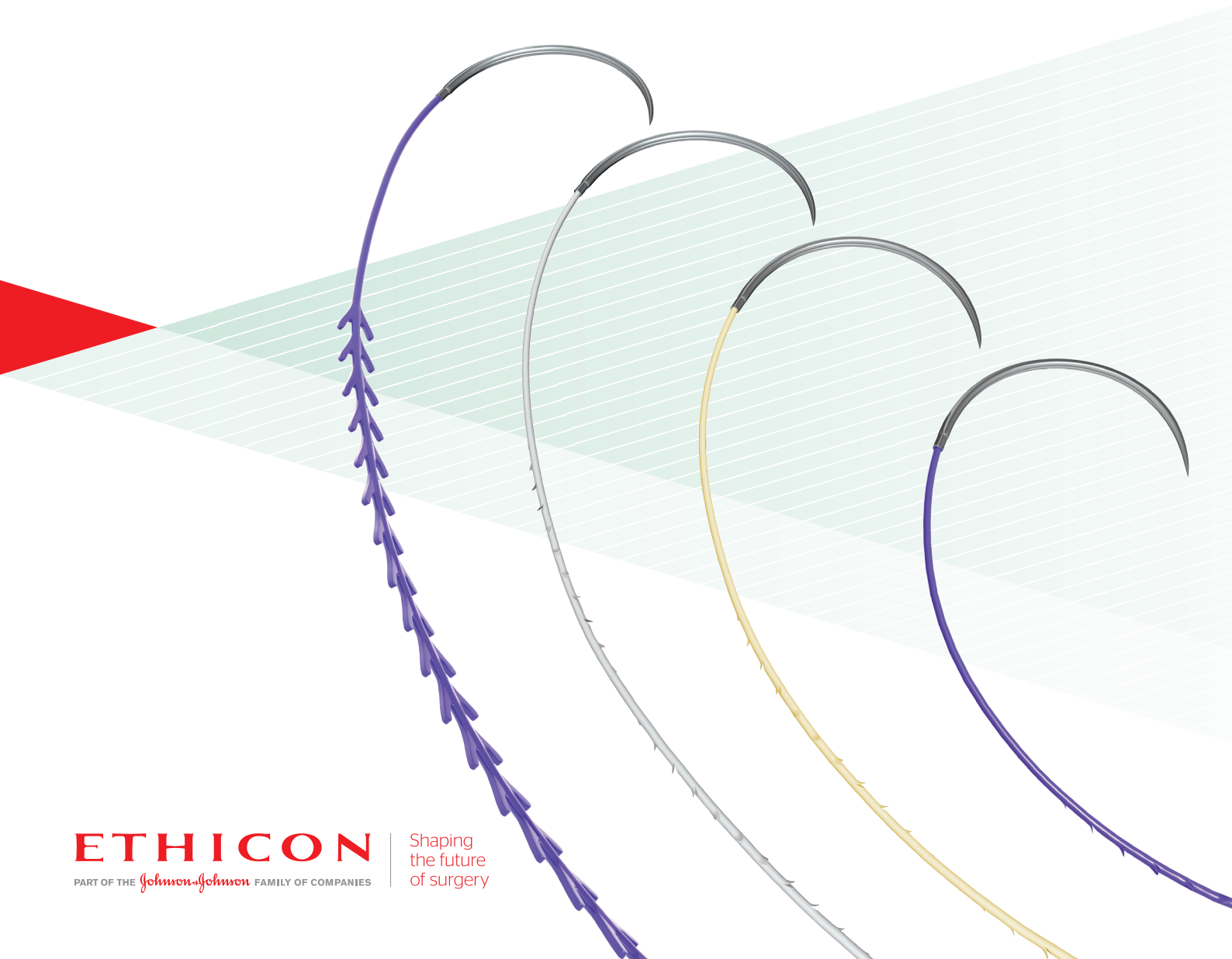

ETHICON
PART OF THE *Johnson & Johnson* FAMILY OF COMPANIES

Shaping
the future
of surgery

STRATAFIX™ Knotless Tissue Control Devices

A versatile portfolio to meet your wound closure needs

Multiple anchor designs and patterns provide more versatility^{1,3}

STRATAFIX™ Symmetric PDS™ Plus Knotless Tissue Control Device

The **only** knotless tissue device that provides strong, secure closure appropriate for high-tension areas such as **fascia**^{1,*}

Symmetric

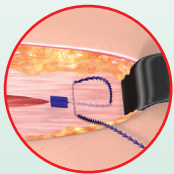

Superior tissue holding strength

STRATAFIX™ Symmetric PDS™ Plus Knotless Tissue Control Device demonstrated superior tissue holding strength compared to interrupted technique with Coated VICRYL™ (polyglactin 910) Suture, continuous technique with PDS™ II (polydioxanone) Suture, and VLoc™ 180 Wound Closure Device.^{1,9}



**

STRATAFIX™ Symmetric PDS™ Plus Device offers **Plus antibacterial technology** to address known risk factors associated with SSI¹

* Refers to STRATAFIX™ Symmetric PDS™ Plus Knotless Tissue Control Device Only.

**The petri dish image is for illustrative purposes only, zone of inhibition testing results can vary.

STRATAFIX™ Spiral Knotless Tissue Control Device

A broad range of **bidirectional** and **unidirectional** devices, offers the **smooth glide** of a traditional suture^{1,2-8}

Spiral

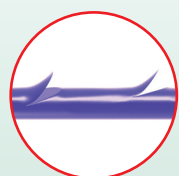

Anchors formed within the core of the device in a **spiral** pattern⁹

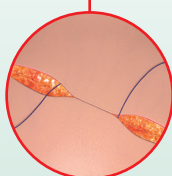

Bidirectional design allows for management of tension from the middle

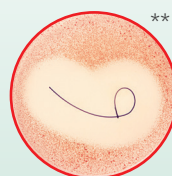









Unidirectional design, **with Plus antibacterial technology**, has adjustable loop on end¹

*Sizing shown represents tensile strength. See IFU for additional information.

In a pre-clinical study, STRATAFIX™ Symmetric PDS™ Plus Knotless Tissue Control Device provided greater wound holding strength than traditional running sutures of the same size and polymer, while eliminating knot-related complications.^{1,10}





- **Only Ethicon** offers tissue control devices, with Plus antibacterial technology, that provide appropriate strength for closing high-tension areas, such as **fascia**^{1, **}
- **Superior tissue holding strength** compared to interrupted technique with Coated VICRYL™ (polyglactin 910) Suture, continuous technique with PDS™ II (polydioxanone) Suture, and V-Loc™ 180 Wound Closure Device.^{1,10}
- **Plus Antibacterial technology** designed to address a known risk factor for SSIs¹

STRATAFIX™ Symmetric PDS™ Plus Knotless Tissue Control Device - Dyed						
Needle		Size* Length (cm)	3-0	2-0	0	1
17 mm, 1/2 Circle Taper Point, RB-1		15	SXPP1A411			
		30	SXPP1A427			
19 mm, 3/8 Circle Reverse Cutting, PS-2		45	SXPP1A101			
24 mm, 3/8 Circle Reverse Cutting, PS-1		45	SXPP1A100			
36 mm, 1/2 Circle Reverse Cutting, OS-6		45			SXPP1A200	SXPP1A201
		60			SXPP1A202	SXPP1A203
40 mm, 1/2 Circle Reverse Cutting, OS-8		60			SXPP1A204	SXPP1A205
26 mm, 1/2 Circle Taper Point, SH		15	SXPP1A413	SXPP1A414		
		23		SXPP1A421		
		30	SXPP1A428	SXPP1A431		
		45	SXPP1A410	SXPP1A409		
26 mm, 1/2 Circle Taper Point, CT-2		15		SXPP1A415		SXPP1A419
		23		SXPP1A422	SXPP1A446	
		45		SXPP1A408	SXPP1A407	
36 mm, 1/2 Circle Taper Point, CT-1		15		SXPP1A416	SXPP1A418	SXPP1A420
		23		SXPP1A423	SXPP1A425	
		30	SXPP1A429	SXPP1A432	SXPP1A433	SXPP1A435
		45		SXPP1A403	SXPP1A401	SXPP1A404
		60		SXPP1A439	SXPP1A440	SXPP1A443
40 mm, 1/2 Circle Taper Point, CT		30			SXPP1A412	
		45			SXPP1A406	SXPP1A405
		60			SXPP1A441	SXPP1A444

** Refers to STRATAFIX™ Symmetric PDS™ Plus Knotless Tissue Control Device Only.

* Sizing shown represents tensile strength. See IFU for additional information.

STRATAFIX™ Symmetric PDS™ Plus Knotless Tissue Control Device - Dyed

Needle		Size* Length (cm)	3-0	2-0	0	1
48 mm, 1/2 Circle Taper Point, CTX		45 60			SXPP1A402 SXPP1A442	SXPP1A400 SXPP1A445
36 mm, 1/2 Circle Taper Point, Ethiguard™ Safety Needle, CTB-1		45 60				SXPP1A301 SXPP1A304
48 mm, 1/2 Circle Taper Point, Ethiguard™ Safety Needle, CTXB		45 60			SXPP1A302	SXPP1A300 SXPP1A306
26 mm, 5/8 Circle Taper Point, UR-6		15		SXPP1A417		
26 mm, 1/2 Circle TAPERCUT™, V-7		23		SXPP1A424		

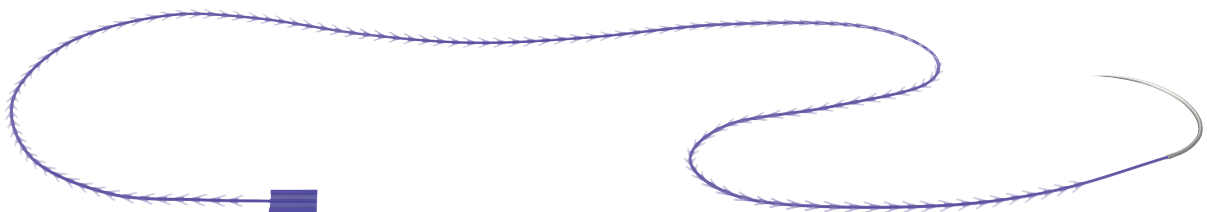







*Sizing shown represents tensile strength. See IFU for additional information.

STRATAFIX™ Spiral Knotless Tissue Control Device: **Unidirectional**

Provides added consistency and efficiency for skin and subcutaneous tissue where tension has been relieved by deeper closure.¹

- Closure begins at one end of an incision, for a familiar wound-closure technique¹
- Adjustable fixation loop secures the device without the need for tying a knot¹
- Suitable for organ closure when additional tension control is appropriate
- Offers Plus antibacterial technology to address risk factors associated with SSI^{11,12}









STRATAFIX™ Spiral MONOCRYL™ Plus Knotless Tissue Control Device - Undyed						
Needle		Size* Length (cm)	4-0	3-0	2-0	0
26 mm, 1/2 Circle Taper Point, SH		15			SXMP1B408	
		23		SXMP1B427	SXMP1B409	
		30			SXMP1B410	
		70		SXMP1B428		
36 mm, 1/2 Circle Taper Point, CT-1		45		SXMP1B429	SXMP1B413	
		70			SXMP1B414	
26 mm, 1/2 Circle Taper Point, CT-2		15			SXMP1B415	
		30			SXMP1B416	
		45			SXMP1B417	
36 mm, 1/2 Circle Reverse Cutting, CP-1		70			SXMP1B419	
26 mm, 1/2 Circle Reverse Cutting, CP-2		30			SXMP1B420	
30 mm, 3/8 Circle Reverse Cutting, PSL		70			SXMP1B421	
17 mm, 1/2 Circle Taper Point, RB-1		15	SXMP1B434	SXMP1B424		
		23	SXMP1B439 [#]	SXMP1B438 [#]		
		30	SXMP1B435	SXMP1B425		

*Sizing shown represents tensile strength. See IFU for additional information.

[#] CE mark pending.

STRATAFIX™ Spiral Knotless Tissue Control Device: **Unidirectional** (continued)

STRATAFIX™ Spiral MONOCRYL™ Plus Knotless Tissue Control Device - Undyed						
Needle		Size* Length (cm)	4-0	3-0	2-0	0
24 mm, 3/8 Circle Reverse Cutting, PS-1		30	SXMP1B114	SXMP1B101		
		45		SXMP1B102		
		60		SXMP1B103		
		70		SXMP1B104		
19 mm, 3/8 Circle Reverse Cutting, PS-2		15		SXMP1B105		
		30	SXMP1B117	SXMP1B106		
		45	SXMP1B118	SXMP1B107		
		60		SXMP1B108		
26 mm, 3/8 Circle Reverse Cutting, PS		45		SXMP1B111		
		70		SXMP1B113		
19 mm, Straight Taper Point, ST-4		30		SXMP1B433		
16 mm, 1/2 Circle Reverse Cutting, PS-4		45	SXMP1B120			

STRATAFIX™ Spiral Polypropylene Knotless Tissue Control Device - Undyed						
Needle		Size* Length (cm)	4-0	3-0	2-0	0
22 mm, 1/2 Circle Taper Point, SH-1		30			SXPL1B400	

*Sizing shown represents tensile strength. See IFU for additional information.

STRATAFIX™ Spiral Knotless Tissue Control Device: **Unidirectional** (continued)

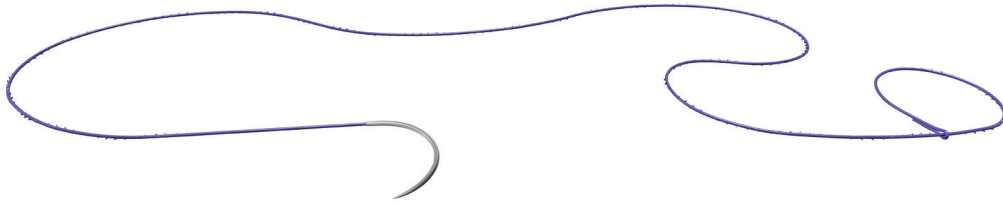









STRATAFIX™ Spiral PDS™ Plus Knotless Tissue Control Device - Dyed

Needle		Size* Length (cm)	3-0	2-0	0	1
36 mm, 1/2 Circle Reverse Cutting, OS-6		45				SXPP1B201
		70				SXPP1B203
40 mm, 1/2 Circle Reverse Cutting, OS-8		70				SXPP1B204
36 mm, 1/2 Circle Taper Point, MO-4		70				SXPP1B205
36 mm, 1/2 Circle Taper Point, CT-1		15		SXPP1B409	SXPP1B406	
		22		SXPP1B456	SXPP1B455	
		30		SXPP1B410	SXPP1B450	SXPP1B429
		45		SXPP1B411	SXPP1B407	SXPP1B430
		70		SXPP1B412	SXPP1B408	SXPP1B431
48 mm, 1/2 Circle Taper Point, CTX		70				SXPP1B401
		90				SXPP1B402
26 mm, 1/2 Circle Reverse Cutting, CP-2		45			SXPP1B202	SXPP1B403
36 mm, 1/2 Circle Tapercut, V-34		23		SXPP1B458	SXPP1B457	
26 mm, 1/2 Circle Taper Point, CT-2		15		SXPP1B413		
		30			SXPP1B405	
31 mm, 1/2 Circle Taper Point, MO-5		70			SXPP1B451	
19 mm, Ski Taper Point, EN-S		30			SXPP1B452	

* Sizing shown represents tensile strength. See IFU for additional information.

STRATAFIX™ Spiral Knotless Tissue Control Device: **Unidirectional** (continued)

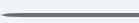







STRATAFIX™ Spiral PDS™ Plus Knotless Tissue Control Device - Dyed						
Needle		Size* Length (cm)	4-0	3-0	2-0	0
26 mm, 1/2 Circle Taper Point, SH		15		SXPP1B420	SXPP1B415	
		23			SXPP1B433	
		30			SXPP1B416	
		70		SXPP1B421	SXPP1B417	
22 mm, 1/2 Circle Taper Point, SH-1		23	SXPP1B454	SXPP1B453		
26 mm, 5/8 Circle Taper Point, UR-6		15			SXPP1B434	
		30			SXPP1B419	
19 mm, 3/8 Circle Reverse Cutting, PS-2		15		SXPP1B103		
		30		SXPP1B104		
		45	SXPP1B113	SXPP1B105		
		70	SXPP1B114			
24 mm, 3/8 Circle Reverse Cutting, PS-1		70		SXPP1B110		
16 mm, 1/2 Circle Reverse Cutting, PS-4		45	SXPP1B119			
22 mm, 1/2 Circle Reverse Cutting, X-1		70		SXPP1B120		
17 mm, 1/2 Circle Taper Point, RB-1		15	SXPP1B427	SXPP1B422		
		30	SXPP1B428			
		70		SXPP1B423		
19 mm, Straight Taper Point, ST-4		15		SXPP1B424		

* Sizing shown represents tensile strength. See IFU for additional information.

STRATAFIX™ Spiral Knotless Tissue Control Device: **Bidirectional**





Allows for management of tension from the middle for control over tissue approximation in challenging conditions like non-linear incisions and larger open wounds.

- Secured with a backstitch or lateral stitch on both ends to finish
- 360-degree spiral anchor patterns¹
- Bidirectional anchors start in the middle and move toward the needles on each end⁹

STRATAFIX™ Spiral PDO Knotless Tissue Control Device - Dyed							
Needle		Size* Length (cm)	4-0	3-0	2-0	0	1
19 mm, 3/8 Circle Reverse Cutting, FS-2		7 x 7 14 x 14	SXPD2B422 SXPD2B423				
26 mm, 3/8 Circle Reverse Cutting, FS		14 x 14 24 x 24		SXPD2B417 SXPD2B419	SXPD2B418 SXPD2B420		
26 mm, 1/2 Circle Reverse Cutting, CP-2		24 x 24				SXPD2B415	SXPD2B416
36 mm, 1/2 Circle Reverse Cutting, OS-6		24 x 24 30 x 30					SXPD2B200 SXPD2B201
40 mm, 1/2 Circle Reverse Cutting, OS-8		36 x 36					SXPD2B202
17 mm, 3/8 Circle Tapercut, V-4		24 x 24	SXPD2B426				
26 mm, 3/8 Circle Tapercut, V-26		14 x 14 24 x 24	SXPD2B425 SXPD2B424				
22 mm, 1/2 Circle Taper Point, CT-3		14 x 14				SXPD2B404	
26 mm, 1/2 Circle Taper Point, SH		10 x 10 14 x 14			SXPD2B413 SXPD2B414		

*Sizing shown represents tensile strength. See IFU for additional information.





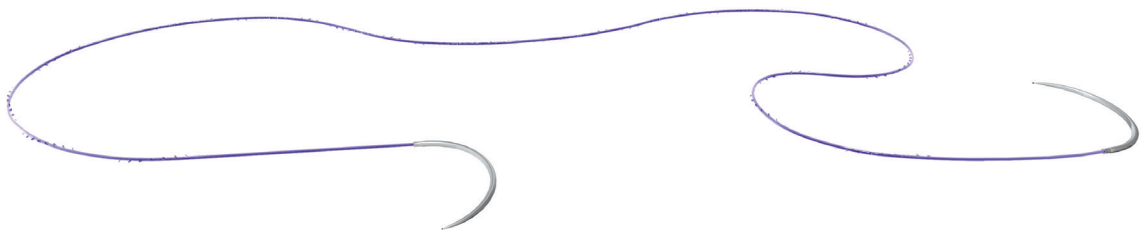

STRATAFIX™ Spiral Knotless Tissue Control Device: **Bidirectional** (continued)

STRATAFIX™ Spiral PDO Knotless Tissue Control Device - Dyed							
Needle		Size* Length (cm)	4-0	3-0	2-0	0	1
36 mm, 1/2 Circle Taper Point, MH		7 x 7			SXPD2B406		
		14 x 14			SXPD2B407	SXPD2B409	
		24 x 24			SXPD2B408	SXPD2B410	
		30 x 30				SXPD2B411	
		36 x 36				SXPD2B412	
36 mm, 1/2 Circle Taper Point, CT-1		14 x 14					SXPD2B401
		24 x 24					SXPD2B402
		30 x 30					SXPD2B403
36 mm, 1/2 Circle Taper Point, MO-4		36 x 36					SXPD2B400
48 mm, 1/2 Circle Taper Point, CTX		36 x 36					SXPD2B405



*Sizing shown represents tensile strength. See IFU for additional information.

STRATAFIX™ Spiral Knotless Tissue Control Device: **Bidirectional** (continued)



STRATAFIX™ Spiral PGA-PCL Knotless Tissue Control Device - Undyed							
Needle		Size* Length (cm)	4-0	3-0	2-0	0	1
19 mm, 3/8 Circle Reverse Cutting, FS-2		7 x 7	SXMD2B405	SXMD2B404			
		14 x 14	SXMD2B407	SXMD2B406			
		30 x 30	SXMD2B409	SXMD2B408			
24 mm, 3/8 Circle Reverse Cutting, FS-1		30 x 30	SXMD2B150	SXMD2B410			
26 mm, 3/8 Circle Reverse Cutting, FS		14 x 14		SXMD2B411			
		30 x 30	SXMD2B413	SXMD2B412			
26 mm, 1/2 Circle Reverse Cutting, CP-2		14 x 14			SXMD2B414		
17 mm, 1/2 Circle Taper Point, RB-1		16 x 16	SXMD2B403	SXMD2B402			
36 mm, 1/2 Circle Taper Point, MH		14 x 14			SXMD2B400		
		36 x 36			SXMD2B401		

† Labeled as Ger PS-1.



*Sizing shown represents tensile strength. See IFU for additional information.

STRATAFIX™ Spiral Knotless Tissue Control Device: **Bidirectional** (continued)

STRATAFIX™ Spiral Polypropylene Knotless Tissue Control Device - Undyed							
Needle		Size* Length (cm)	4-0	3-0	2-0	0	1
22 mm, 1/2 Circle Taper Point, CT-3		14 x 14				SXPL2B401	
36 mm, 1/2 Circle Taper Point, CT-1		24 x 24					SXPL2B400



*Sizing shown represents tensile strength. See IFU for additional information.

A **versatile** knotless tissue control device portfolio

STRATAFIX™ knotless tissue control devices	Symmetric PDS™ Plus	Spiral MONOCRYL™ Plus	Spiral PDS™ Plus	Spiral Polypropylene	Spiral PDO	Spiral PGA - PCL
Barb Design						
Fixation Type	Tab	Loop	Loop	Loop / Central	Central	Central
Gauge sizes	3-0 to 1	4-0 to 2-0	4-0 to 0	2-0 to 1	4-0 to 1	4-0 to 2-0

Tissue Type	Wound Support 4,5	Symmetric PDS™ Plus	Spiral MONOCRYL™ Plus	Spiral PDS™ Plus	Spiral Polypropylene	Spiral PDO	Spiral PGA - PCL
Skin (subcuticular)	1 - 2 weeks	▼	✓	▼	▼	▼	✓
Fat (subcutaneous)	1 - 2 weeks	✓	✓	✓	▼	▼	✓
Fascia	3+ weeks	✓	▼	▼	▼	▼	▼
Muscle	4 - 6 weeks	✓	▼	✓	▼	✓	▼
Organ	Varies	✓*	▼	✓*	✓*	✓	▼

With significantly more points of fixation than traditional sutures, STRATAFIX™ Knotless Tissue Control Devices provide a combination of **more security**, **more consistency**, and **more efficiency**.^{1,3, 5,7}

Only Ethicon offers tissue control devices, with Plus antibacterial technology, that provide appropriate strength for closing high-tension areas, such as **fascia**.^{1,‡}

* Please always refer to the Instructions for Use / Package Insert that come with the device for the most current and complete instructions.

‡ Refers to STRATAFIX™ Symmetric PDS™ Plus Device only.

References: 1. Data on file, Ethicon, Inc. STRATAFIX™ Knotless Tissue Control Devices Consolidated Claims Matrix 060056-170214 EMEA. 2. Moran ME, Marsh C, Perrotti M. Bidirectional-barbed sutured knotless running anastomosis vs classic Van Velthoven suturing in a model system. *J Endourol.* 2007;21(10):1175-8. 3. Vakil JJ, O'Reilly MP, Sutter EG, et al. Knee arthroscopy repair with a continuous barbed suture: biomechanical study. *J Arthroplasty.* 2011;26(5):710-3. 4. Rodeheaver GT, Piñeros-Fernandez A, Salopek LS, et al. Barbed sutures for wound closure: in vivo wound security, tissue compatibility and cosmesis measurements. In: Transactions from the 30th Annual Meeting of the Society for Biomaterials; Mount Laurel, NJ; p. 232. 5. Eickmann T, Quane E. Total knee arthroplasty closure with barbed sutures. *J Knee Surg.* 2010;23(3):163-167. 6. Einarsson JI, Chavan NR, Suzuki Y, et al. Use of bidirectional barbed suture in laparoscopic myomectomy: evaluation of perioperative outcomes, safety, and efficacy. *J Minim Invasive Gynecol.* 2011;18(1):92-95. 7. Levine BR, Ting N, Della Valle CJ. Use of a barbed suture in the closure of hip and knee arthroplasty wounds. *Orthopedics.* 2011;34(9):e473-e475. 8. Warner JP, Gutowski KA. Abdominoplasty with progressive tension closure using a barbed suture technique. *Aesthet Surg J.* 2009;29(3):221-225. 9. Ethicon Inc, SFX-487-13, Monoderm CADD Drawings, Aug 2012, Data on File. 10. Ethicon, 100326296: Time Zero Tissue Holding - Competitive Claims Comparisons for STRATAFIX™ Knotless Tissue Control Devices vs Various Products. Data on File. May 2015. 11. Ming X, Rothenburger S, Nichols MM. In vivo and in vitro antibacterial efficacy of PDS Plus (polydioxanone with triclosan) suture. *Surg Infect (Larchmt).* 2008;9(4):451-457. 12. Ming X, Rothenburger S, Nichols MM. In vivo and in vitro antibacterial efficacy of PDS Plus (polydioxanone with triclosan) suture. *Surg Infect (Larchmt).* 2008;9(4):451-457.

Other Products



DERMABOND™

Beyond sutures and staples lies a more innovative solution

DERMABOND™ PRINEO™ Skin Closure System (22 cm)



Powerful combination of 2-octyl cyanoacrylate (2-OCA) and self-adhering mesh

Protection

- Provides a flexible microbial barrier with 99% protection in vitro for 72 hours against organisms commonly responsible for SSIs.^{1*}
 - Demonstrates in vitro inhibition of gram-positive (MRSA and MRSE) and gram-negative bacteria (E. coli)^{2†}

Strength

- statistically significant greater skin holding strength than skin staples or subcuticular 4-0 MONOCRYL™ (poliglecaprone 25) suture^{4‡}
- Redistributes tension away from the wound to the surrounding healthy surface area¹⁰

Patient Satisfaction

- Patient may be able to shower immediately after the procedure, if directed by the healthcare professional⁵
- At the time of removal, DERMABOND™ PRINEO™ System is associated with less pain than other wound closure devices⁶
- No post-surgical dressings may mean easier self-care and greater self-confidence for patients⁷

ETHICON
PART OF THE *Johnson & Johnson* FAMILY OF COMPANIES

Shaping
the future
of surgery

*Staphylococcus epidermidis, Escherichia coli, Staphylococcus aureus, Pseudomonas aeruginosa, and Enterococcus faecium
†Clinical significance unknown
‡In an ex-vivo study, more load in N was required to create a 3±1 mm gap between skin edges approximated with DERMABOND PRINEO System, than with subcuticular 4-0 MONOCRYL™ Suture or PROXIMATE Ethicon Endo-Surgery skin staples (p=0.00).

PRINEO*

Skin Closure System



PRINEO* Skin Closure System is intended to replace subcuticular/ intradermal suturing when there is no tension on the wound or when tension has been relieved by deep dermal or subcutaneous sutures.

PRINEO* Skin Closure System significantly reduces closure time by combining advanced mesh technology with a topical skin adhesive. The system provides microbial barrier and maintains skin approximation until removed. Enables patients to shower immediately following a procedure.

PRINEO* Skin Closure System consists of a self adhering, pressure-sensitive adhesive (PSA), polyester-based mesh for temporarily holding together the approximated skin edges of an incision and a 2-octyl cyanoacrylate liquid adhesive formulation for final skin/wound closure of incisions

Time Savings

- OR procedure time
- Anesthesia
- Post-Op Management

Suture Closure Equivalence

- Equivalent or Better Dehiscence
- Equivalent or Better Cosmesis

Ease of Use

- Wound Edge Approximation
- Minimal Learning Curve

Patient Comfort

- Ability to Shower Immediately
- No Blistering

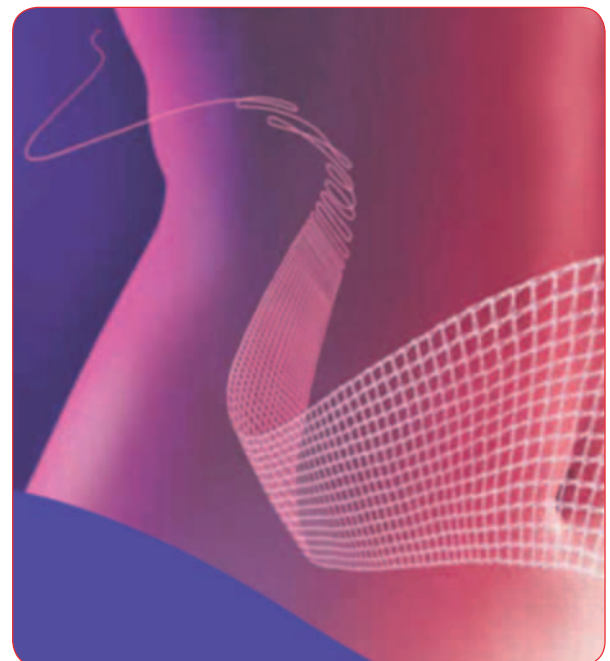

Product Name	Size	Packaging	Product Code
PRINEO* 60 Skin Closure System	Mesh dispenser contains 60 cm of mesh	2 Units	CLR602
PRINEO* 22 Skin Closure System	Mesh patch 22 cm	Per Box	CLR222
PRINEO* 42 Skin Closure System	Mesh patch 2 x 22cm		CLR422

Other products



INTRODUCING DERMABOND ADVANCED

Product Overview

- Superior strength and microbial protection versus other commercially available topical skin adhesives_{2,3}
- Single-layer application and reduced drying time₂

Product Performance

- Adds 75% more strength to the wound closure than sutures alone, when used in addition to sutures₂
- In vitro inhibition of gram-positive bacteria (MRSA and MRSE) and gram-negative bacteria (E coli)*
- Provides a microbial barrier with >99% protection in vitro for at least 72 hours against organisms commonly responsible for SSIs_{4**}

Patient benefits

DERMABOND® Adhesive has benefits that enhance patient comfort and satisfaction_{5,6}, such as:

- Excellent cosmesis_{7,8}
- Ability to shower immediately after application₉
- No need to remove sutures or change dressings₇

References

2. Data of File, Ethicon, Inc.
3. Singer AJ, Perry LC, Allen RL. In vivo study of wound-bursting strength and compliance of topical skin adhesives. *Acad Emerg Med*. 2008;15(12):1290-1294.
4. Bhende S, Rothenburger S, Spangler DJ, Dito M. In vitro assessment of microbial barrier properties of Dermabond Topical Skin Adhesive. *Surg Infect (Larchmt)*. 2002;3 (3):251-257.
5. Nipshagen MD, Hage JJ, Beekman W. Use of 2-octyl-cyanoacrylate skin adhesive (Dermabond) for wound closure following reduction mammoplasty: a prospective, randomized intervention study. *Plast Reconstr Surg*. 2008;122:10-18.
6. Scott GR, Carson CL, Borah G. Dermabond skin closures for bilateral reduction mammoplasties: a review of 255 consecutive cases. *Plast Reconstr Surg*. 2007;120:1460-1465.
7. Toriumi DM, O'Grady K, Desai D, Bagal A. Use of octyl-2-cyanoacrylate for skin closure in facial plastic surgery. *Plast Reconstr Surg*. 1998;102:2209-2219.
8. Quinn J, Wells G, Sutcliffe T, et al. A randomized trial comparing octylcyanoacrylate tissue adhesive and sutures in the management of lacerations. *JAMA*. 1997;277(19):1527-1530.
9. Rubio PA. Use of semioclusive, transparent film dressings for surgical wound protection: experience in 3637 cases. *Int Surg*. 1991;76:253-254.



The Range at a Glance

DERMABOND* Mini	Small vial for use in the emergency room
DERMABOND* Regular	Regular vial for use in the emergency room
DERMABOND* ProPen	For use in the OR
DERMABOND* ProPen XL	For use in the OR, for longer incisions
DERMABOND* ADVANCED	New improved formula, for use in the OR



Product Name	Size	Packaging	Product Code
DERMABOND* Mini	0.36 ml	12 Ampoules	AHVM12
DERMABOND* Regular	0.5 ml	6 Ampoules	AHV6
DERMABOND* Regular	0.5 ml	12 Ampoules	AHV12
DERMABOND* ProPen	0.5 ml	6 Ampoules	APP6
DERMABOND* ProPen XL	0.75 ml	6 Ampoules	APPXL6
DERMABOND* Advanced	0.7 ml	6 Ampoules	ANX6
DERMABOND* Advanced	0.7 ml	12 Ampoules	ANX12

Other products

BLAKE* Silicone Drains

BLAKE Drains offer excellent drainage with four continuous channels that provide greater tissue contact area than regular perforated drains in addition to multiple drainage routes to resist clogging.¹ BLAKE Drains are constructed of silicone, with a solid-center design for strength and flexibility.





The drains are available with and without Ethicon's patented bendable TROCAR technology, which can be angled to facilitate easier placement of the drain (Round Hubless BLAKE Drains only).

The design of the drains allows greater patient comfort and enhanced ambulation. Patients experience less discomfort upon removal, greater ease of mobility postoperatively, and less discomfort during patient movement and deep breathing exercises.^{2,3,4}

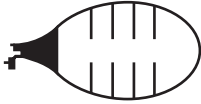

REFERENCES

- 1 Frankel TL. Silastic drains vs conventional chest tubes after coronary artery bypass. *Chest*. 2003; 124: 108-113.
- 2 Payne M. Left pleural effusion after coronary artery bypass decreases with a supplemental pleural drain. *Ann Thorac Surg*. 2002; 73:149-152.
- 3 Obney JA. A method for mediastinal drainage after cardiac procedures using small silastic drains. *Ann Thorac Surg*. 2000; 70:1109-1110.
- 4 Gundy SR. Facile minimally invasive cardiac surgery via ministernotomy. *Ann Thorac Surg*. 1998; 65:1100-1104.

Product	Material	Packaging	Code
J-VAC RESERVOIRS			
	100 cc Bulb Suction Reservoir	10 Per Box	2160
		150 ml Reservoir 450 ml Reservoir 300 ml Reservoir	10 Per Box 10 Per Box 10 Per Box
SILICONE DRAINS			
	7 mm Flat, 3/4 Fluted	10 Per Box	2210
	10 mm Flat, 3/4 Fluted		2213
	10 mm Flat, Full Fluted		2214
	10 mm Flat, Full Fluted, 3/16" Trocar		2215
	Hubless, 10 FR Round	10 Per Box	2226
	Hubless, 10 FR Round, 1/8" Trocar		2227
	Hubless, 15 FR Round		2228
	Hubless, 15 FR Round, 3/16" Trocar		2229
	Hubless, 19 FR Round		2230
	Hubless, 19 FR Round, 1/4" Trocar		2231
	Hubless, 19 FR Round, 1/4" Bendable Trocar		2232
	Hubless, 15 FR Round, 3/16" Bendable Trocar		2233
Hubless, 24 FR Round	2234		
CARDIO CONNECTORS			
	Cardio Connector 1:1	20 Per Box	BCC1
	Cardio Connector 2:1	20 Per Box	BCC2
	Cardio Connector 3:1	20 Per Box	BCC3

Other products

POWERSTAR* bipolar scissors



BIPOLAR SCISSORS FOR OPEN SURGERY

PowerStar scissors are multifunctional, for precise cutting, dissecting and achieving hemostasis with one instrument.

This leads to fewer instrument changes, thus reducing operating time and allowing an uninterrupted focus on the surgical site.

The safety of advanced bipolar technology mini-mises undesired collateral tissue damage, as the current only passes through the tissue between the blades.

Because of the short bipolar current pathway, PowerStar may be a safer alternative to monopolar surgery in patients with pacemakers or implants and may reduce ECG interferences.

The two blades of the scissors are insulated from one another to form the active electrodes of the bipolar instrument. This is achieved by applying a ceramic coat to one surface of the scissor blade and clear surface hardening to the other. An insulated screw is inserted and the handles are coated.

PowerStar scissors are available in various lengths and designs to best suit your requirements. Cables with different connectors can be obtained to ensure compatibility with most electrosurgery generators.

POWERSTAR®

POWERSTAR* bipolar scissors

	Product	Code
	PowerStar Tenotomy 115 mm (4 1/2') curved	BP 100
	PowerStar Mayo 170 mm (6 3/4') curved	BP 720
	PowerStar Metzenbaum 175 mm (7') curved	BP 520
	PowerStar Metzenbaum 230 mm (9') curved	BP 540
	PowerStar Metzenbaum 280 mm (11') curved	BP 560
	PowerStar Metzenbaum Fine 175 mm (7') curved	BP 320
	PowerStar Metzenbaum Fine 230 mm (9') curved0	BP 340
	PowerStar Metzenbaum Fine 280 mm (11') curved	BP 360

POWERSTAR* Cable

Generator	Other information	Code
Martin, Berchtold, Wolf, Aesculap	5 m	BP 910
Erbe, Storz	5 m	BP 930
Pegasys, Valleylab	5 m, fixed "banana"	BP 940





Other products

PROXIMATE PLUS MD

Stapler-grip Skin Staplers

Ease of Use



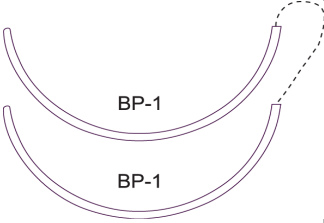
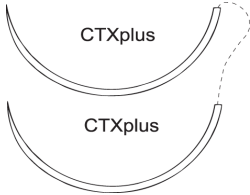
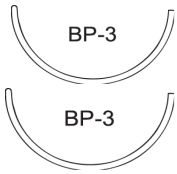

- The ergonomic design of the non-reloadable, disposable Proximate Plus handle ensures easy handling.
- The staples are applied by pressing the handle, with no further movement in any direction.

		Staple size	Staple span	No. of staples	Pieces/box	Product Code
	Rotating head	Wide	6,9 mm	35	6	PRW35
	Fixed head	Regular Wide	5,7mm 6,9mm	35 35	6 6	PXR35 PXW35
	Fixed head	Regular Wide	5,7mm 6,9 mm	35 35	6 6	PMR35 PMW35
	STAPLE EXTRACTOR				12	PSX

MERSILENE* Tape (flat)

Needle	Needle size and type	Size	Length (cm)	Other info	Color	Number per box	Code
	65mm blunt point needle	5 mm	40		WHITE	12	RS21G
	48mm taper point needle	5 mm	40		WHITE	12	RS22G
	35mm blunt point needle	5 mm	40		WHITE	12	RS23G

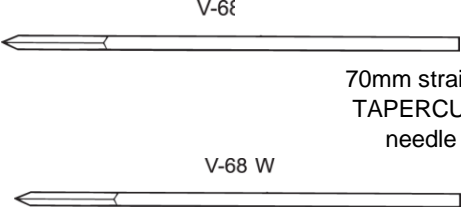

PDS* Cord (multifilament, round)

Needle	Needle size and type	Size	Length (cm)	Other info	Color	Number per box	Code
	36mm taper point needle	0,8 mm	75		VIOLET	12	Z809G
	48mm cutting needle	1 mm	75		VIOLET	12	Z812G
 <p style="text-align: center;">70mm straight TAPERCUT* needle</p>		1,3 mm	75		VIOLET	3	ZK1328
	48mm TAPERCUT* needle	1,5 mm	75		VIOLET	12	Z838G
Non-needed		2 mm	70	Round cord with transosseus wire for temporary stress protection of anterior cruciate ligament	VIOLET	3	ZK2017

PDS* Tape (multifilament, flat)

Needle	Material	Size	Length (cm)		Color	Number per box	Code
Non-needed	PDS*	5 mm	30	Flat tape	VIOLET	3	ZH503
Non-needed	PDS*	7,5 mm	60	Flat tape	VIOLET	3	ZH706

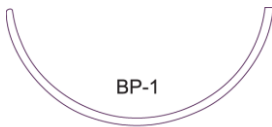
VICRYL* Tape (flat)

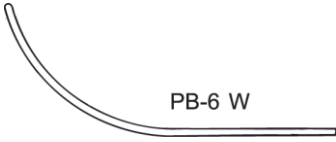
Needle	Needle size and type	Size	Length (cm)		Color	Number per box	Code
 BP-1	65mm blunt point needle	3 mm	60		VIOLET	12	V152G
 BP-2	48mm blunt point needle	3 mm	60		VIOLET	12	V153G
 PB-6 W	69mm blunt ski needle	3 mm	60		VIOLET	12	V159G
Non-needed	VICRYL*	10 mm	30		VIOLET	3	VH1003

Cotton Umbilical Tape (multifilament, flat)







Needle	Material	Size	Length (cm)		Color	Number per box	Code
Non-needed	Cotton	5 mm	2x75		WHITE	24	U11T

Nylon tape (multifilament, flat)

Needle	Material	Size	Length (cm)		Color	Number per box	Code
Non-needed	Nylon	3 mm	70		WHITE	12	W275
Non-needed	Nylon	6 mm	70		WHITE	12	W277

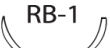
TEMPORARY PACING WIRES

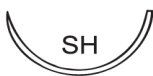
Monopolar





Needles	Needle size	Length (cm)	Gauge	Color	Code
 <p>BB SKS</p> 	17 mm 3/8 circle taper point	60	2-0	Blue	TPW20
	60 mm straight cutting				
 <p>RB-1 SKS</p> 	17 mm 1/2 circle taper point	60	2-0	Blue	TPW10
	60 mm straight cutting				
 <p>SH</p> <p>SKS-3</p> 	26 mm 1/2 circle taper point	60	2-0	Blue	TPW30
	90 mm straight cutting	2x60	2-0	Dark blue, light blue	TPW32

ENDOLOOP*

Size mm	Suture Color	Length (cm)	Other information	Number per box	Code
3-0	●		PDS* II loop ligature	12	MIC108G
2-0	●		PDS* II loop ligature	12	MIC109G
0	●		PDS* II loop ligature	12	MIC110G
0	●	50	VICRYL* loop ligature	12	EJ11
0	●	50	PDS* loop ligature	12	EZ11
0	●	90	PROLENE* loop	12	EH464G
1	●		PDS* II loop ligature	12	MIC111G
1	●		PDS* II loop ligature, large	12	MIC113G

Other products

Endosutures

Needle	Size mm	Suture Color	Length (cm)	Other information	Number per box	Code	
 BB	17 mm	3-0	7	PDS* II, with 2 medium-sized ABSOLOK clips	24	MIC54E	
		3-0	10	PDS* II, with 2 medium-sized ABSOLOK clips	24	MIC55E	
 ST-4 VISI-BLACK	19 mm	4-0	20	VICRYL*	36	MIC103H	
		3-0	20	VICRYL*	36	MIC573H	
		3-0	7	PDS* II, with 2 medium-sized ABSOLOK clips	24	MIC52E	
		2-0	100	PDS* II ETHI-ENDO-NAHT Suture ligature	12	MIC133G	
SKI-22	22 mm	2-0	20	Silk	24	E4103S	
 JB	26 mm	2-0	20	PDS* II	36	MIC160H	
		2-0	120	ETHIBOND* Excel	36	MIC253H	
 JBT VISI-BLACK	26 mm	3-0	20	PDS* II	36	MIC182H	
		2-0	120	ETHIBOND* Excel	36	MIC252H	
		2-0	100	PDS* II ETHI-ENDO-NAHT Suture ligature	12	MIC131G	
		3-0	20	VICRYL*	36	MIC552H	
		3-0	20	VICRYL*	36	MIC582H	
		2-0	120	VICRYL*	36	MIC585H	
		3-0	120	VICRYL*	36	MIC586H	

ETHILOOP* Silicone Vessel Slings



Needle	Size mm	Suture Color	Length (cm)	Other information	Number per box	Code
BPS-4 	25 mm	1,1	45	2 per pack, 3/8 circle blunt point needle	24	EH7700E
Non-neededled	1,3	○	45	2 per pack	24	EH382E
	1,3	●	45	2 per pack	24	EH383E
	1,3	●	45	2 per pack	24	EH384E
	2	○	45	2 per pack	6	EH386
	2	●	45	2 per pack	6	EH387
	2	●	45	2 per pack	6	EH388
	2	●	45	2 per pack	6	EH389